

25 July 2025

**ASX Announcement**

# Strategic NSW Copper-Gold-Silver-Lead-Zinc project portfolio acquisition

Kingfisher Mining Limited (**ASX:KFM**) ("**Kingfisher**" or the "**Company**") is pleased to announce that it has entered into a Binding Agreement with Austin Metals Ltd (**ASX:AYT**) ("**Austin**") for the acquisition of a portfolio of early stage to advanced Copper-Gold, Gold and Silver Lead Zinc projects located in the Broken Hill, Cobar and the Macquarie Arc regions in NSW. The tenement package comprising eleven tenements covering approximately 700 square kilometres in area.

These include:

- Copper Blow Iron Oxide Copper Gold (IOCG) Project (Broken Hill, NSW).
- Multiple Copper and Silver-Lead-Zinc prospects (Broken Hill, NSW).
- Wellington Copper Project (Macquarie Arc, NSW).
- Tindery Gold and base metal Project (Cobar, NSW).
- Copper Blow IOCG prospect hosts high grade copper gold mineralisation which has been defined by historical drilling over 600 metres of strike, historical drill results include:
  - **16m @ 2.67% Cu, 0.62 g/t Au and 4.04 g/t Ag from 133m in 84DDHCB06**
  - **4m @ 6.13% Cu, 4.23 g/t Au and 12.93 g/t Ag from 188m in 17CB041**
  - **7m @ 3.7% Cu, 1.07 g/t Au and 5.5 g/t Ag from 126m in 17CB045**
  - **4m @ 3.48% Cu, 2.39 g/t Au and 5.9 g/t Ag from 177m in 84DDHCB06**
  - **8.22m @ 1.87% Cu, 0.53 g/t Au and 3.09 g/t Ag from 131.78m in 17CB043**
  - **41.2m @ 1.27% Cu, 0.4 g/t Au and 1.53 g/t Ag from 183.8m inc. 7m @ 2.23% Cu and 0.99 g/t Au from 189m in 18CB054**
  - **22m @ 1.08% Cu, 0.31 g/t Au and 1.63 g/t Ag from 278m inc. 15m @ 1.31 %Cu and 0.32 g/t Au from 285m in 18CB057**
- West Broken Hill, multiple Ag-Pb-Zn prospects, located NW of Broken Hill associated with historic mines which have seen significant historical exploration undertaken. High grade drill results from most recent drilling in 2011 at Allendale include:
  - **10m @ 16.1% Pb+Zn and 29 g/t Ag from 15m in RCAN002**
  - **2m @ 19.9% Pb+Zn and 39.2 g/t Ag from 47m in RCAN011**
  - **2m @ 13.8% Pb+Zn and 51.1 g/t Ag from 117m in RCAN016**
  - **3m @ 13.2% Pb+Zn and 31.0g/t from 78m in RCAN019**
- Wellington copper-gold Project located in the Macquarie Arc in NSW within favourable volcanic stratigraphy. The key asset is the Willunga prospect located 15km away from the Boda/Kaiser porphyry-copper deposit.
- Tindery Project located north of Cobar in NSW hosts a cluster of small historical gold workings with limited historic drilling at the northern end of the Chesney Fault, which is a major structural feature related to a number of economic deposits to the south near Cobar.

The acquisition represents significant value for Kingfisher shareholders, with a total consideration of \$200,000 in cash and \$200,000 in Kingfisher shares to be issued to Austin upon completion.

Kingfisher's Non-Executive Chairman Scott Huffadine commented:

"We are excited by the opportunity that is the culmination of significant evaluation work by the Kingfisher team over the last 12 months in reviewing multiple projects leading to this commitment. This acquisition represents a compelling exploration opportunity with access to a strategic asset portfolio, providing exposure to a pipeline of early stage and advanced, critical and precious metal targets located proximal to a number of world class deposits in three proven mining districts in NSW, whilst still providing the option value on the Gascoyne Rare Earth project in Western Australia".

Kingfisher Mining Ltd ("KFM" or the "Company") (ASX:KFM) is pleased to announce that it has entered into a Binding Agreement for the acquisition of three highly prospective copper-gold, gold and, and silver-lead-zinc exploration projects, comprising 11 tenements totalling approximately 700 square kilometres in area. The projects include:

**Broken Hill Project**, including the Copper Blow IOCG prospect, Yalcowinna project copper cobalt prospects and the Broken Hill West prospects, multiple silver-lead-zinc targets focussed around historic mining centres, including Allendale, Maybell, Parnell and Stephen Trig comprising 9 granted exploration licenses EL's 7300,8075,8077,8078,8236,8495,8605,8862 and 8863. (Table 1)

**Wellington Copper-Gold Project**, including the Willunga copper prospect comprising one exploration license EL 8972, within the Macquarie Arc NSW. (Table 1)

**Tindery Gold Project, comprising** one exploration licence, EL 8579, Cobar NSW. (Table 1)

Tenement	Name	Holder	Interest (%)	Area (units)	Grant Date	Expiry Date	Comments
EL 7300	Aragon	Austin Metals Ltd	85	18		23/02/2009	23/02/2026
EL 8075	Willyama	Austin Metals Ltd	75	40	15/04/2013	15/04/2025	Renewal Application Lodged and Under Assessment
EL 8077	Razorback	Austin Metals Ltd	100	23	15/04/2013	15/04/2025	Renewal Application Lodged and Under Assessment
EL 8078	Yalcowinna	Austin Metals Ltd	100	36	15/04/2013	15/04/2025	Renewal Application Lodged and Under Assessment
EL 8236	Native Dog	Austin Metals Ltd	75	4		11/02/2014	11/02/2026
EL 8495	Southern Cross	Austin Metals Ltd	100	5		22/12/2016	22/12/2026
EL 8579	Tindery	Austin Metals Ltd	100	32		26/05/2017	26/05/2029
EL 8685	Aspen	Austin Metals Ltd	100	2		23/01/2018	23/01/2030
EL 8862	Clevedale	Austin Metals Ltd	75	8	17/06/2019	17/06/2025	Renewal Application Lodged and Under Assessment

EL 8863	Himalaya	Austin Metals Ltd	75	29	17/06/2019	17/06/2025	Renewal Application Lodged and Under Assessment
EL 8971	Wellington	Austin Metals Ltd	100	71		23/04/2020	22/04/2026

### Capital Raising

The Company is pleased to announce it is conducting a capital raising of approximately \$1,854,300 (before costs) through a placement to sophisticated and professional investors and a subsequent non-renounceable entitlement issue to eligible shareholders.

#### Placement

The Company has received firm commitments from sophisticated and professional investors to raise \$520,000 (before costs) through the issue of 13,000,000 shares (**Placement Shares**) at an issue price of \$0.04 per share, together with one (1) free-attaching option (exercisable at \$0.10 and expiring three (3) years from the date of issue) (**Placement Options**) for every two (2) Placement Shares subscribed for and issued (a total of 6,500,000 Placement Options) (**Placement**). The issue price of \$0.04 per share represents a 18.0% discount to the 10-day VWAP of \$0.04881 per share and a 17.6% discount to the 15-day VWAP of \$0.048553 per share.

The Placement Shares will be issued without shareholder approval and pursuant to the Company's existing capacity under Listing Rules 7.1 and 7.1A. The Placement Options will be issued subject to prior shareholder approval.

#### Rights Issue

In conjunction with the Placement, the Company is undertaking a pro-rata non-renounceable entitlement issue of one (1) share (**New Share**) for every two (2) existing shares held by eligible shareholders at an issue price of \$0.04 each to raise up to approximately \$1,334,300 (**Rights Issue**). Each subscriber will also be entitled to receive one (1) free-attaching option (exercisable at \$0.10 and expiring three (3) years from the date of issue) (**New Options**) for every two (2) New Shares subscribed for under the Rights Issue.

The Rights Issue is being made to all shareholders of the Company named on its register of members at 5:00pm (WST) on Tuesday, 12 August 2025 (**Record Date**), whose registered address is in Australia, New Zealand or Singapore. A total of 33,357,501 New Shares and 16,678,751 New Options will be issued pursuant to the Rights Issue (assuming no shares are issued prior to the Record Date other than the Placement Shares).

All New Shares issued will rank equally with existing shares on issue.

A transaction specific prospectus in relation to the Rights Issue will be lodged with ASIC on Wednesday, 6 August 2025 (**Prospectus**).

The Company has engaged CPS Capital Group Pty Ltd (ABN 73 088 055 636) (**CPS Capital**) to act as lead manager of the Placement. CPS Capital will receive a fee equal to 6% on the amount raised under the Placement and Rights Issue and, subject to shareholder approval, the Company will issue CPS Capital (and/or its nominees) a total of 6,500,000 options (exercisable at \$0.10 and expiring 3 years from date of issue).

#### Use of Funds

The funds raised from the Placement and Rights Issue will be used towards:

- Exploration on the NSW projects
- Continuing evaluation of the Mick Well REE Project
- working capital; and
- expenses of the Placement and Right Issue.

### Timetable

The proposed timetable for the Placement and Rights Issue is set out below:

EVENT	DATE <sup>1,2</sup>
Announcement of Placement and Rights Issue and lodgement of Appendix 3B with ASX	Friday, 25 July 2025
Issue of Placement Shares	31 July 2025
Lodgement of Prospectus with ASIC and ASX	Wednesday, 6 August 2025
Ex Date	Monday, 11 August 2025
Record Date for determining shareholder entitled to participate in the Rights Issue	Tuesday, 12 August 2025
Prospectus and Entitlement and Acceptance Form dispatched to Eligible Shareholders, and Company announces that this has occurred	Friday, 15 August 2025
Opening date of the Rights Issue	Friday, 15 August 2025
Last day to extend Closing Date of the Rights Issue	Thursday, 21 August 2025
Closing Date (5:00pm WST)	Tuesday, 26 August 2025
Securities quoted on a deferred settlement basis	Wednesday, 27 August 2025
Last day for Company to announce the results of the Rights Issue, issue the New Shares under the Rights Issue and lodge an Appendix 2A	Tuesday, 2 September 2025

### Notes:

- These dates are indicative only. The Directors reserve the right to vary the key dates without prior notice, subject to the Listing Rules.
- The Directors may extend the Closing Date by giving at least three Business Days' notice to ASX prior to the Closing Date. Accordingly, the date the New Shares are expected to commence trading on ASX may vary.

### Key Terms of the Acquisitions

The Company has entered into a binding sale and purchase heads of agreement (**Acquisition Agreement**) to acquire 100% of the legal and beneficial interest that Austin Metals Ltd (ACN 130 933 309) (**Vendor**) holds in eleven (11) exploration licences located in the Broken Hill, Cobar and the Macquarie Arc regions in New South Wales (**Acquisition**).

A summary of the key terms of the Agreement are set out below:

- (a) The Company will acquire a 100% of the legal and beneficial interest that the Vendor holds in:
- six (6) exploration licences, which the Vendor holds a 100% legal and beneficial interest in; and
  - five (5) exploration licences, which the Vendor holds in joint-venture with third parties,

(together, the **Project Tenements**).

- (b) Details of the Project Tenements and the Vendor's interest in each Project Tenement which will be acquired by the Company is set out in the table above.

- (c) The consideration to the Vendor under the Acquisition Agreement will comprise:
- (i) \$200,000 in cash; and
  - (ii) subject to shareholder approval, that number of fully paid ordinary shares in the capital of the Company equal in value to \$200,000 calculated based on a deemed issue price equal to the 5-day VWAP prior to execution of the Acquisition Agreement (**Consideration Shares**), representing 4,000,000 Consideration Shares.
- (d) Completion of the Acquisition Agreement is subject to satisfaction (or waiver) of a number of conditions precedent, including (but not limited to):
- (i) the Company obtaining all require shareholder approvals to give effect to the transactions contemplated under the Acquisition Agreement, including (but not limited to) shareholder approval for the issue of the Consideration Shares;
  - (ii) the Company and Vendor obtaining all necessary third-party approvals, consents and waivers (if any) to allow the parties to lawfully completion the Acquisition Agreement; and
  - (iii) in relation to EL 8075, EL 8077, EL 8078, EL 8862 and EL 8863 (**Expiring Tenements**):
    - (A) the Company receiving evidence from the Vendor, in a form acceptable to the Company, that the term of each of the Expiring Tenements has been extended for a further period and on such terms acceptable to the Company; or
    - (B) the Buyer being satisfied that the land which is the subject of the Expiring Tenements is otherwise secured by way of the Company (with the Company's consent in accordance with the Mining Act) applying for one or more exploration licences over the same area as the Expiring Tenements in accordance with the Mining Act.

In accordance with the Acquisition Agreement, the Company has applied for exploration licences over the same area as the Expiring Tenements with the consent of the Vendor.

### **Capital Structure**

The indicative capital structure of the Company following completion of the Placement, Rights Issue and the Acquisition is set out below:

<b>Shares</b>	<b>Number</b>
Shares currently on issue	53,715,001
Consideration Shares	4,000,000
Placement	13,000,000
Rights Issue	33,357,501
<b>Total Shares</b>	<b>104,072,502</b>
<b>Options</b>	<b>Number</b>
Options currently on issue	2,450,000
Placement	6,500,000
Rights Issue	16,678,751
Lead Manager Options	6,500,000
<b>Total Options</b>	<b>32,128,751</b>

**Strategic Rationale**

Following the Company's success at the Gascoyne Rare Earths project at Mick Well, the global rare earths market has remained challenging and the Company commenced project reviews with a focus on forward facing critical metals, predominantly copper and precious metals including gold and silver. This current opportunity with its favourable entry terms and established portfolio of early stage and advanced prospects allows the Company to continue to accrete value whilst still retaining exposure to the Mick Well Rare Earth project until the market recovers. The opportunity provides stakeholders with the exposure to a range of commodities and projects that have the potential to significantly add to this existing asset base.

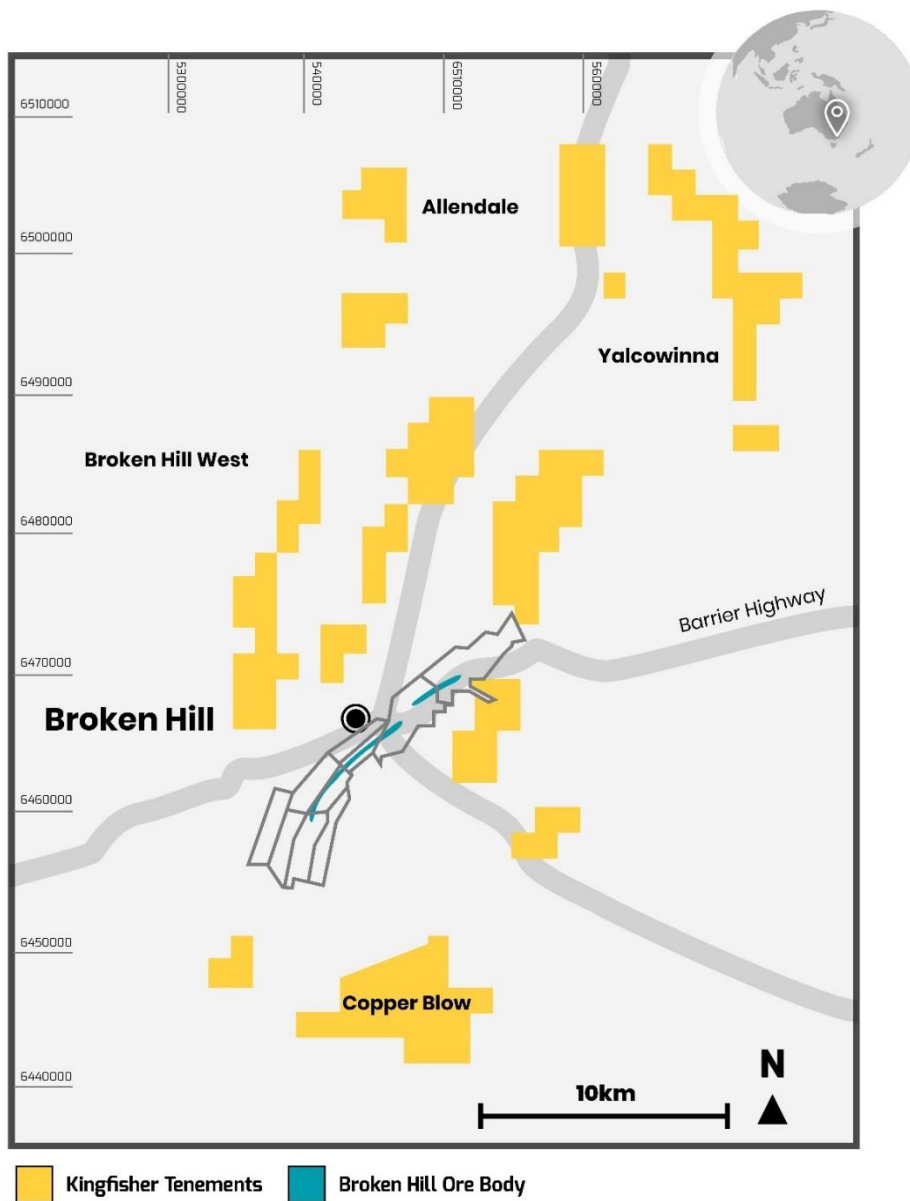
**Projects**
**Broken Hill**

**Figure 1. Broken Hill Projects Location plan**

**Copper Blow copper-gold Project (EL8862 and EL8863) Broken Hill, NSW (75% KFM)**

The Copper Blow project is located 20km SE of the city of Broken Hill. Copper Blow is an Iron Oxide Copper Gold (IOCG) prospect which hosts high grade copper and gold mineralisation. The project is held under a Joint Venture agreement with Kingfisher as part of the transaction maintaining a 75% interest and Broken Hill Mines 25%. Austin Metals/Silver City has completed 32 drill holes for over 8,400 metres over four rounds of drilling from August 2017 to September 2018. It includes 4,460m of reverse circulation drilling and 4,034m of core drilling. Drilling shows that copper-gold mineralisation occurs as sulphides within a magnetic ironstone, the Copper Blow Shear zone. Additional drilling was completed by Acacia Resources Ltd in 1994 and Triako Resources in 2004.

Following successful drilling results, Silver City Minerals Ltd completed preliminary metallurgical sighter test work in 2018 which indicated copper recoveries of 96% in a rougher concentrate. No Mineral Resource estimate has been completed on the Copper Blow mineralisation. There is over 4.5km of prospective stratigraphy with approximately one kilometre of strike mineralisation effectively tested by Austin and earlier explorers. Mineralisation has been defined over 2 separate zones a North and a South Zone separated by a fault over 600 metres of strike. The Southern zone appears to be characterised by more discrete high grade copper gold zones whilst the north zone is characterised by broader lower grade copper gold grades. Historical shallow RAB drilling between 3 and 12m depth by Rasturn Pty Ltd in 1984 was completed on 300m spaced lines over the 4.5km. A line of deeper RC holes to a maximum depth of 108m was drilled by Triako Resources in 2004 approximately 1.2km North of the historic workings. The drilling especially the RAB is not considered to be drilled to an effective depth to test potential mineralisation given the potential plunge of the mineralisation. Results from historical RC and diamond drilling focussed on the North and South ore zones include:

- **16m @ 2.67% Cu, 0.62 g/t Au and 4.04 g/t Ag from 133m in 84DDHCB06**
- **4m @ 6.13% Cu, 4.23 g/t Au and 12.93 g/t Ag from 188m in 17CB041**
- **7m @ 3.7% Cu, 1.07 g/t Au and 5.5 g/t Ag from 126m in 17CB045**
- **4m @ 3.48% Cu, 2.39 g/t Au and 5.9 g/t Ag from 177m in 84DDHCB06**
- **8.22m @ 1.87% Cu, 0.53 g/t Au and 3.09 g/t Ag from 131.78m in 17CB043**
- **41.2m @ 1.27% Cu, 0.4 g/t Au and 1.53 g/t Ag from 183.8m inc. 7m @ 2.23% Cu and 0.99 g/t Au from 189m in 18CB054**
- **22m @ 1.08% Cu, 0.31 g/t Au and 1.63 g/t Ag from 278m inc. 15m @ 1.31 %Cu and 0.32 g/t Au from 285m in 18CB057**

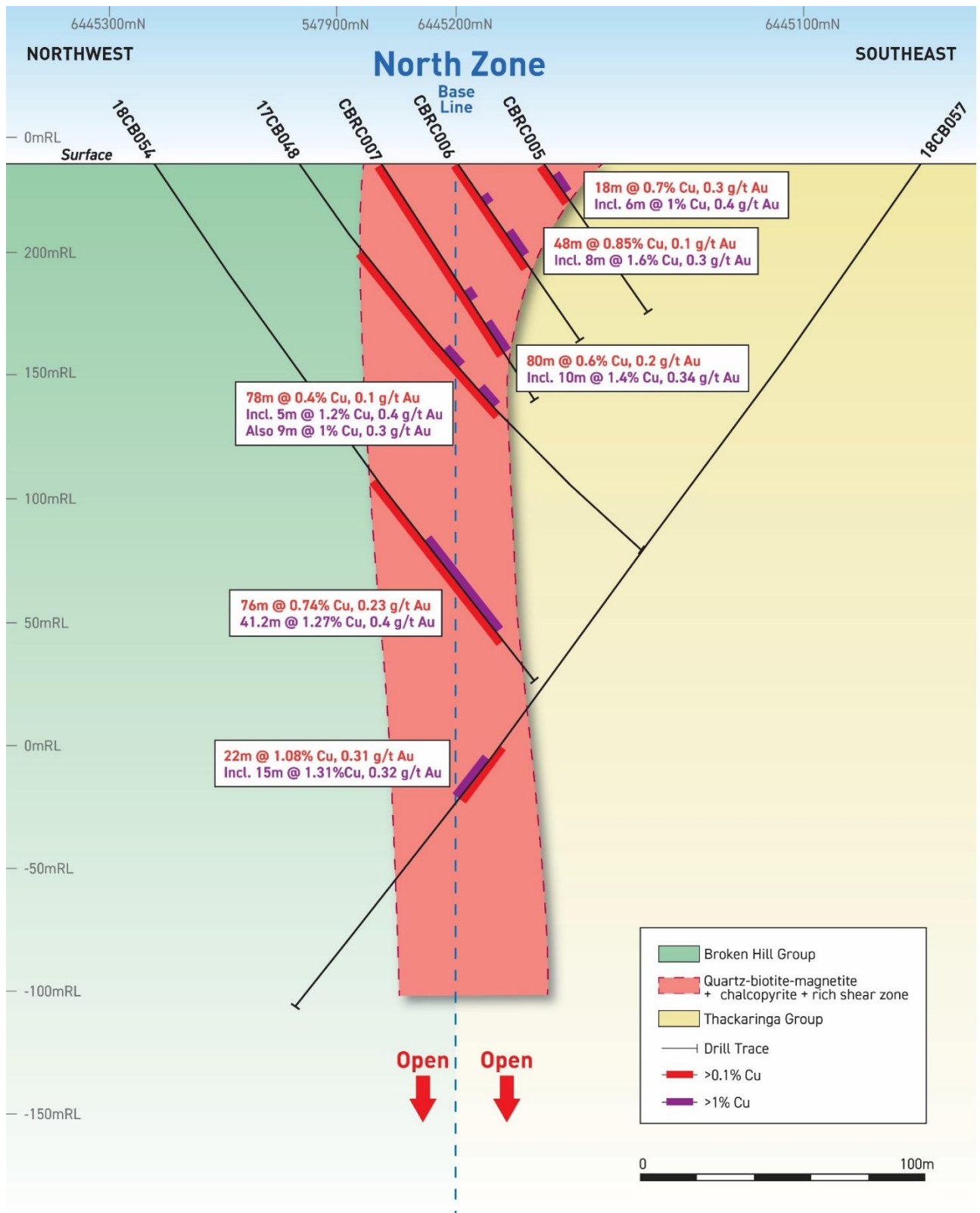

**Figure 2. Copper Blow Cross Section North Zone**

For personal use only

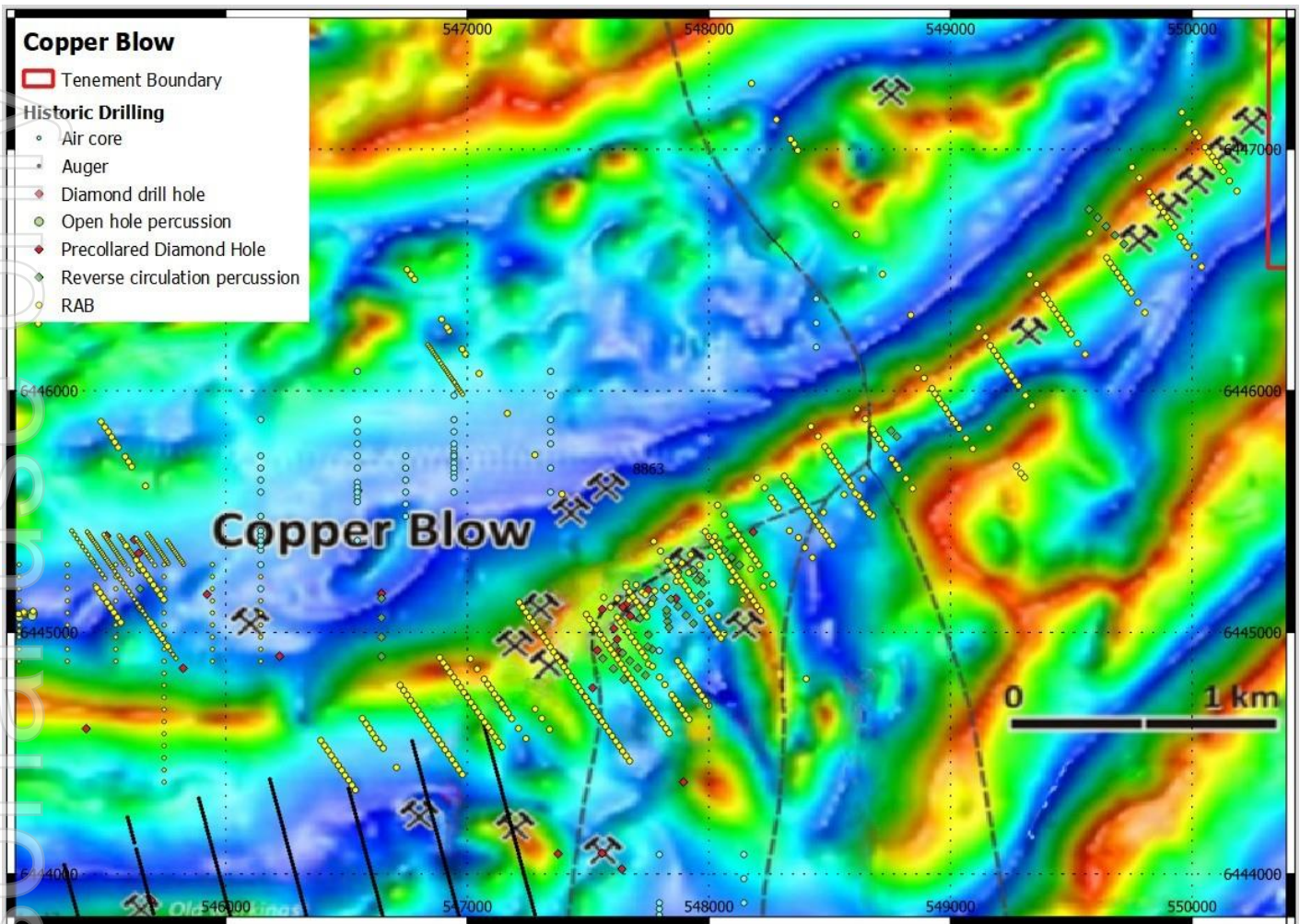

**Figure 3.** Copper Blow magnetics with historic drilling.

Copper Blow is considered to be the largest IOCG prospect in the Broken Hill Block. Past recorded production totals 726 tonnes of copper-rich ore between 1887–1937. It has been classified as a Sisters-type deposit (Barnes 1988), who defines it as epigenetic syn- to late-tectonic strata bound Fe–Cu–Au mineralisation. Barnes 1988 describes the Sisters-type quartz–magnetite horizons as stratigraphically controlled and dominantly developed within the Thackaringa Group rocks. They comprise of quartz–magnetite zones with locally abundant apatite with accessory orthoamphibole, biotite, feldspar, epidote and retrograde chlorite–muscovite. Pyrite (commonly cobaltiferous) and/or pyrrhotite are abundant in many zones whilst chalcopyrite is minor but widespread.

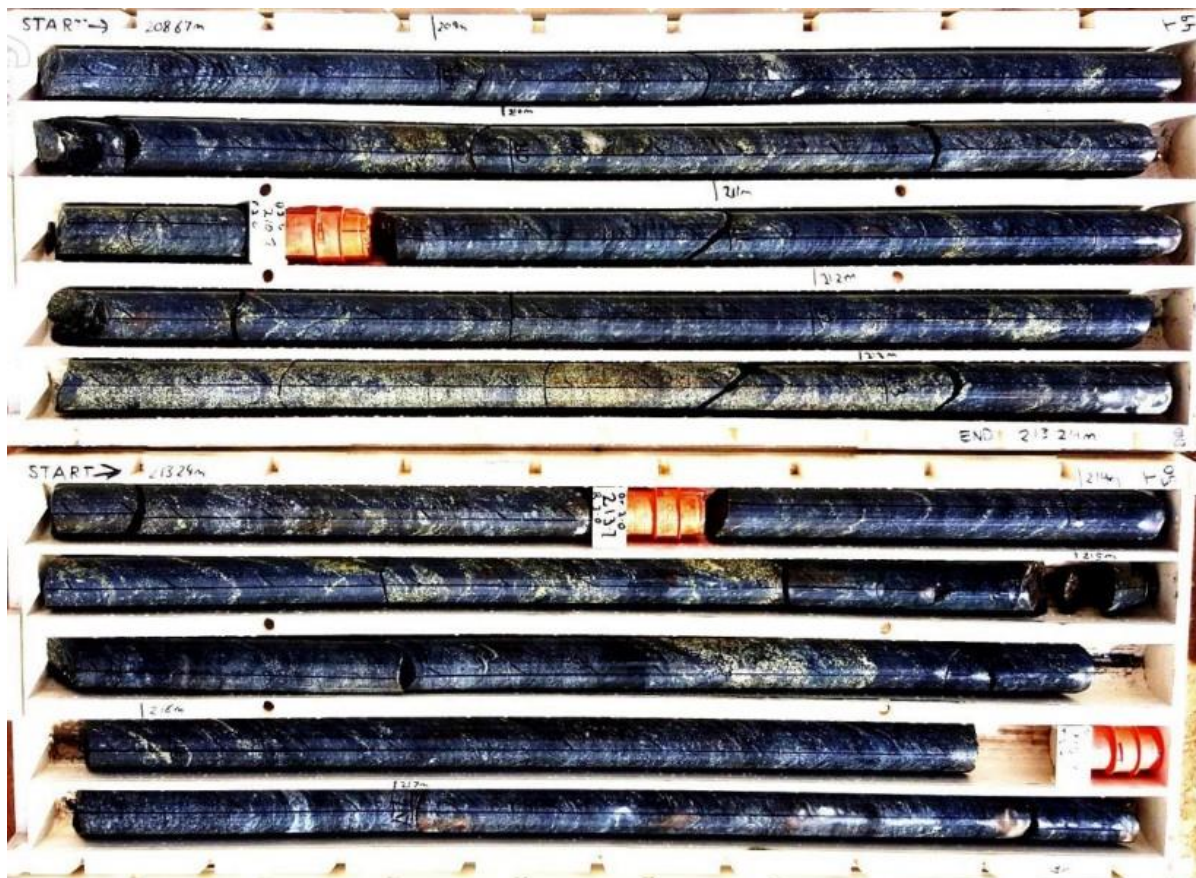

*Hole 18CB054 intersection disseminated chalcopyrite-pyrite with accessory pyrrhotite in magnetite-chlorite quartz shear, 7m @ 1.97% Cu and 0.48 g/t Au from 208m downhole ( see assay table)*

Kingfisher sees a near term opportunity to evaluate the remaining untested strike extent of the host stratigraphy of the Copper Blow mineralisation over 3.5kilometres. This will involve review of the existing geophysical dataset and infill and extensional drilling to the existing 600m of strike already defined at Copper Blow with a view to complete an initial JORC compliant Mineral Resource estimate.

#### **West Broken Hill Lead-Zinc-Silver Prospects (EL 8075 75% KFM, EL 8077 100% KFM, EL 7300 85% KFM and EL 8495 100% KFM)**

Located between 10-40km NNW of Broken Hill the projects are located in and around a number of historic mines associated with the Parnell Formation of the Broken Hill Group with a particular focus on the historic Allendale mine. The lithologies seen at Allendale in mapping and historic drilling include a garnet biotite gneiss, amphibolites and both metamorphosed psammitic and pelitic sediments. Late pegmatites crosscut the sequence as is seen elsewhere in the region. Mineralisation is characterised by base metal sulphides hosted in what was referred historically to as "lode rock" and is made up of bluish granular quartz and a garnet quartzite. Exploration was undertaken from the late 60's and North Broken Hill Ltd carried out a limited diamond drilling program around the old workings in 1969 targeting IP anomalies and a major sulphide body. Best results were in DDHA1 which returned 2.7m @ 12.7% Pb+Zn and 55 g/t Ag from 67.5m. Silver city undertook RC drilling in 2011 with best results including:

- **10m@16.1% Pb+Zn and 29 g/t Ag from 15m, inc. 1m@ 38.3% Pb+Zn and 80.1 g/t Ag from 15m and 2m@ 33.8% Pb+Zn and 43.3 g/t Ag from 18m in RCAN002**
- **2m@ 19.9% Pb+Zn and 39.2 g/t Ag from 47m in RCAN011**
- **2m@ 13.8% Pb+Zn and 51.1 g/t Ag from 117m in RCAN016**
- **3m @ 13.2% Pb+Zn and 31.0g/t from 78m in RCAN019**

Kingfisher sees the opportunity to review the historic drilling at all these prospects and focus on smaller scale high grade opportunities where the silver tenor is higher.

For personal use only

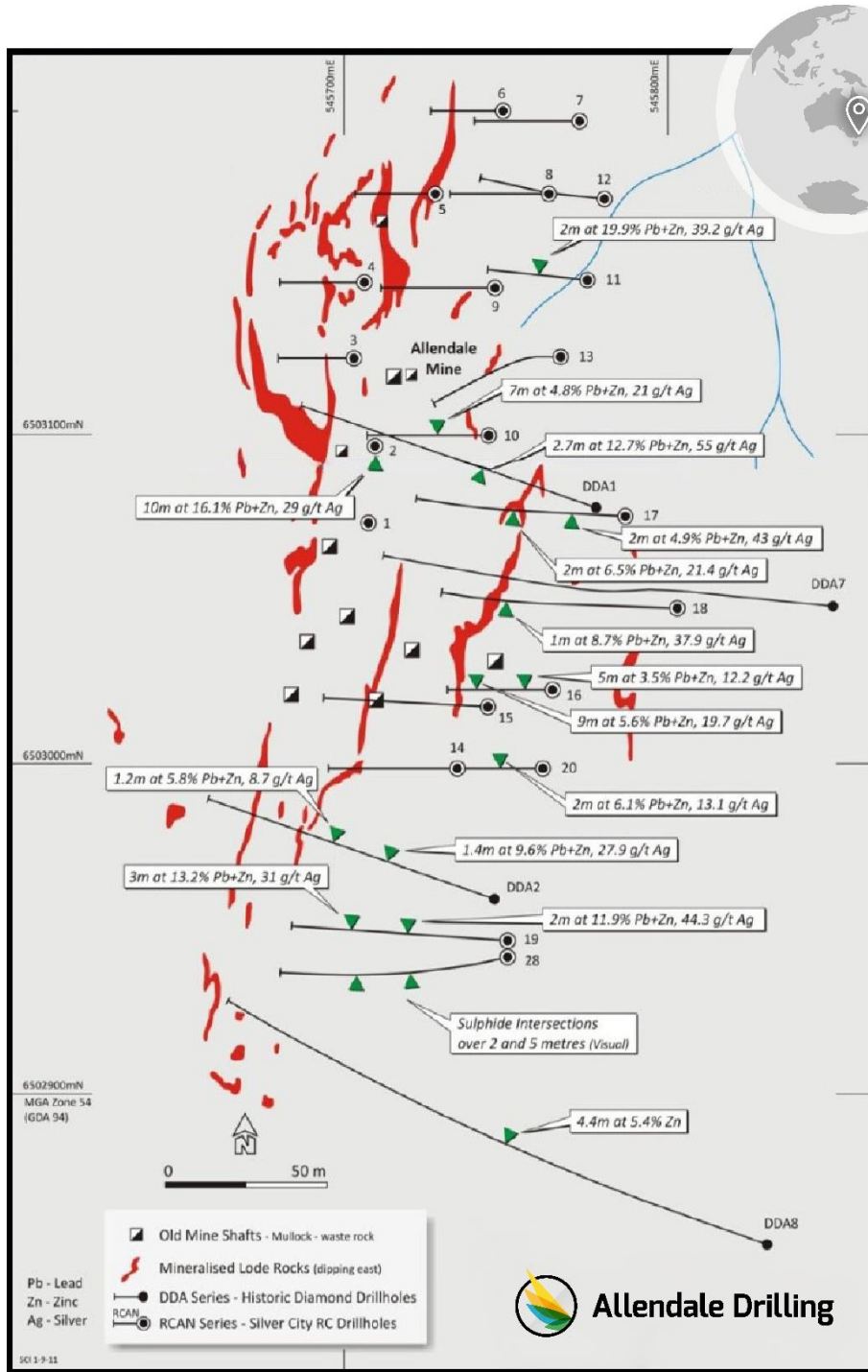

**Figure 4.** Allendale drilling after SCi:ASX announcement 27 September 2011 (see public report for drillhole details)

**Broken Hill- Yalcowinna Copper cobalt prospects (EL8078) (100% KFM)**

The Yalcowinna tenement package is located 30 kilometres to the northeast from Broken Hill and extends for over 25 kilometres of strike with historic rock chip sampling indicating a belt of copper and copper-cobalt occurrences. The area has old workings at several prospects and been the subject of historic drilling predominantly shallow RAB however limited deeper RC drilling has been undertaken around Mt Brown and Fairy Hill workings and gossan, with broad low grade copper intersected at Fairy Hill. Copper mineralisation was previously identified during field mapping by the NSW Geological Survey and former explorers. Multiple gossans remain untested.

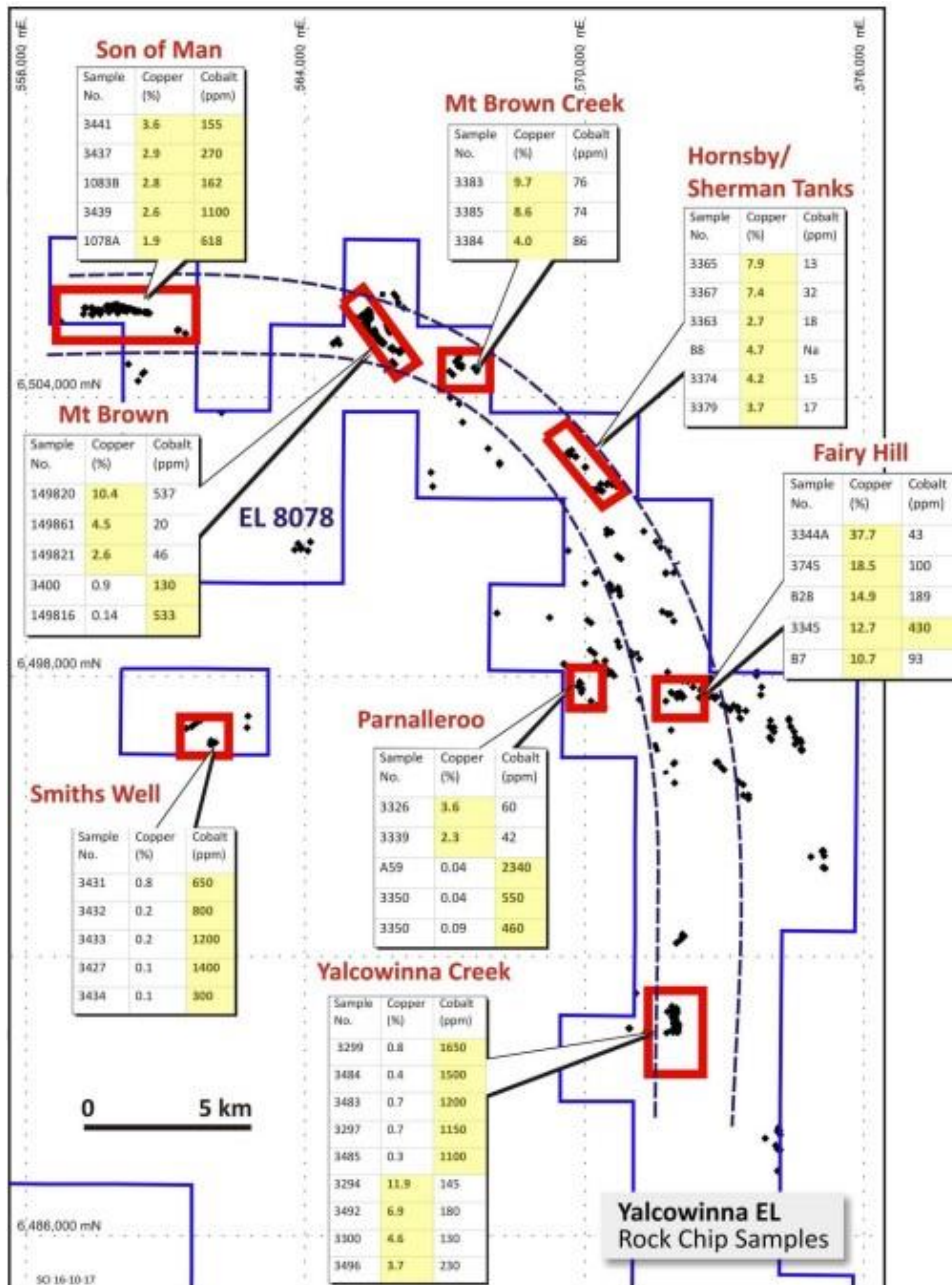
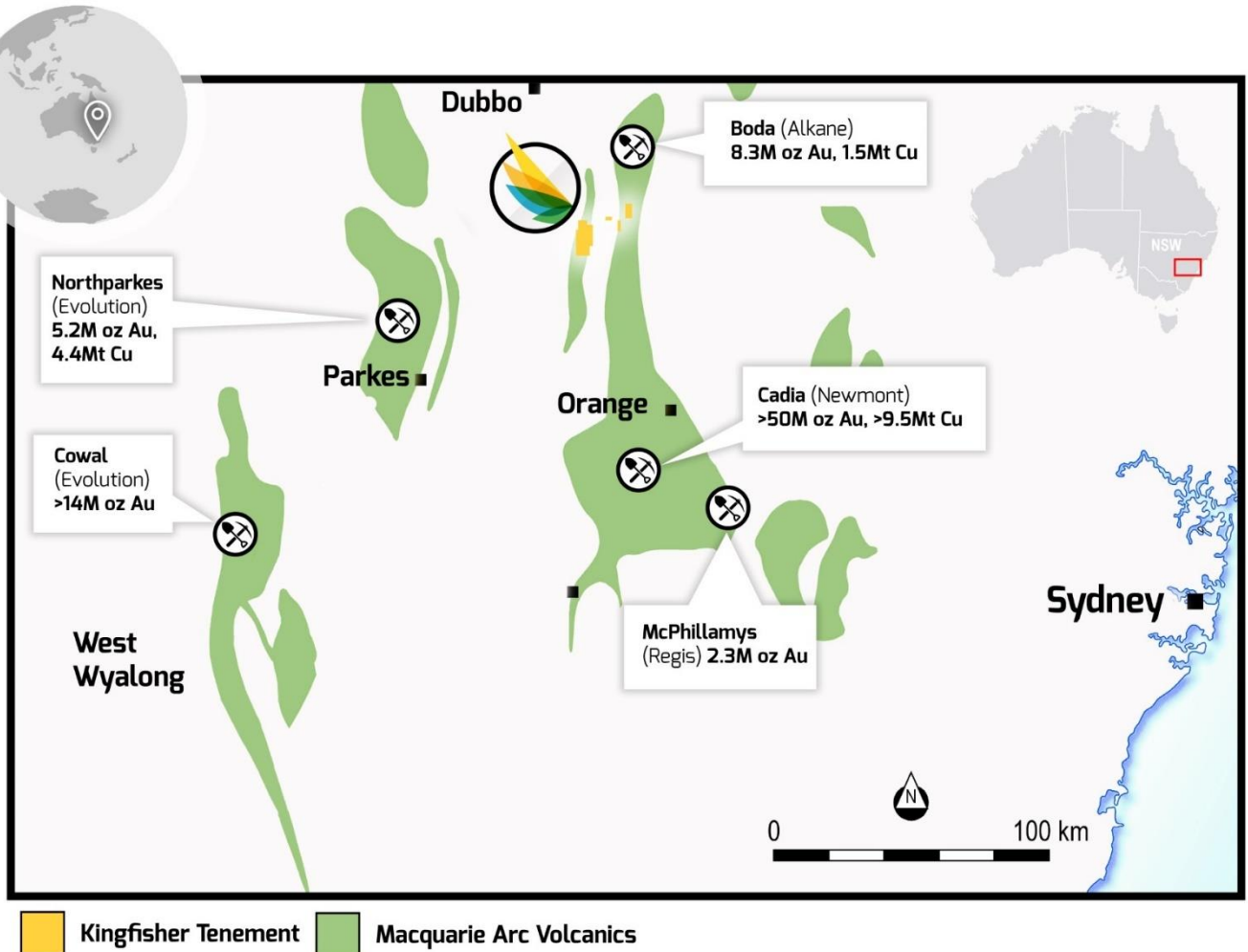

Figure 5. Yalcowinna rock chips from SCl:ASX announcement 17 October 2017

**Wellington Copper–Gold Project (EL 8971) Macquarie Arc, NSW, 100% KFM**

Located in the Macquarie Arc within favourable volcanic stratigraphy, the key prospect is the Willunga prospect located 15km away from the Boda/Kaiser porphyry–copper deposits owned by Alkane, which hosts an estimated Indicated and Inferred Mineral Resource containing 8.3 Moz Au and 1.5Mt of Cu\*



**Figure 6.** Location plan Wellington project

(Total metal endowment from Harris et al 2020, Alkane 2024, Regis 2023 and Evolution 2023)

For personal use only

All of these prospects were explored by Placer in the late 60s with Placer defining a 1200m long copper anomaly with peak values up to 2,000 ppm copper hosted in andesite at Willunga. A continuous 50 ppm molybdenum anomaly was also defined over the eastern end of the copper anomaly and had peak values of 80ppm molybdenum. Limited surface workings were identified in mapping by Placer and no records of historic production are cited. A summary from the 1968 Placer exploration report states: "Interest was focussed on the property by copper mineralization – mainly malachite and azurite in old gougings in the andesite. Pyrite, chalco-pyrite, chalcocite, and molybdenite are also present in smaller amounts, in most cases in quartz. A dump, however, contains appreciable molybdenite and chalcopyrite in granitic material". (Placer 1968)

2 diamond drill holes were drilled by Placer in 1967 targeting geochemical anomalies and IP targets.

D.D.H. W1 was drilled -at 40-degree dip to azimuth 040 to approximately 108.5m total depth, the hole intersected andesite with sporadic chalcopyrite and less molybdenite and went into aplite dykes and granite to the end of the hole.

D.D.H. W2 was drilled at-45-degree dip to azimuth 040 to approximately 215m total depth, the hole intersected sheared and foliated andesite with minor chalcopyrite before grading into greywacke and siltstone with more significant sulphides as pyrite and minor chalcopyrite over 7 metres from 193m downhole. Eighteen samples were taken with no gold and very low copper and molybdenum values results returned. A spectrographic scan was undertaken on a 3m interval from 154 metres downhole and returned 238ppm Cu, 2ppm Ag, 8ppm W, 40ppmTe and 45ppm Sb.

It was concluded from this work was that no further exploration was considered warranted at this time. Interestingly Boda was evaluated at the same time and the same conclusion was drawn, whilst more work was undertaken on the Kaiser deposit Placer did not consider it to have the potential to be of a scale that warranted further attention at that time. (Placer 1968).

The broader tenure has been covered by regional scale stream sediment sampling which assayed for base metal suites, minimal precious metal gold and silver assay and limited multi-element trace element geochemistry. Limited RAB, cable and mud rotary drilling was undertaken on the western tenure. Kingfisher considers this project to still represent an exciting early-stage exploration play and proposes to undertake initial ground-based geophysics to identify any potential targets for drill testing at Willunga. ANT ambient noise tomography has been effectively deployed elsewhere in the region to assist in targeting mineralisation.

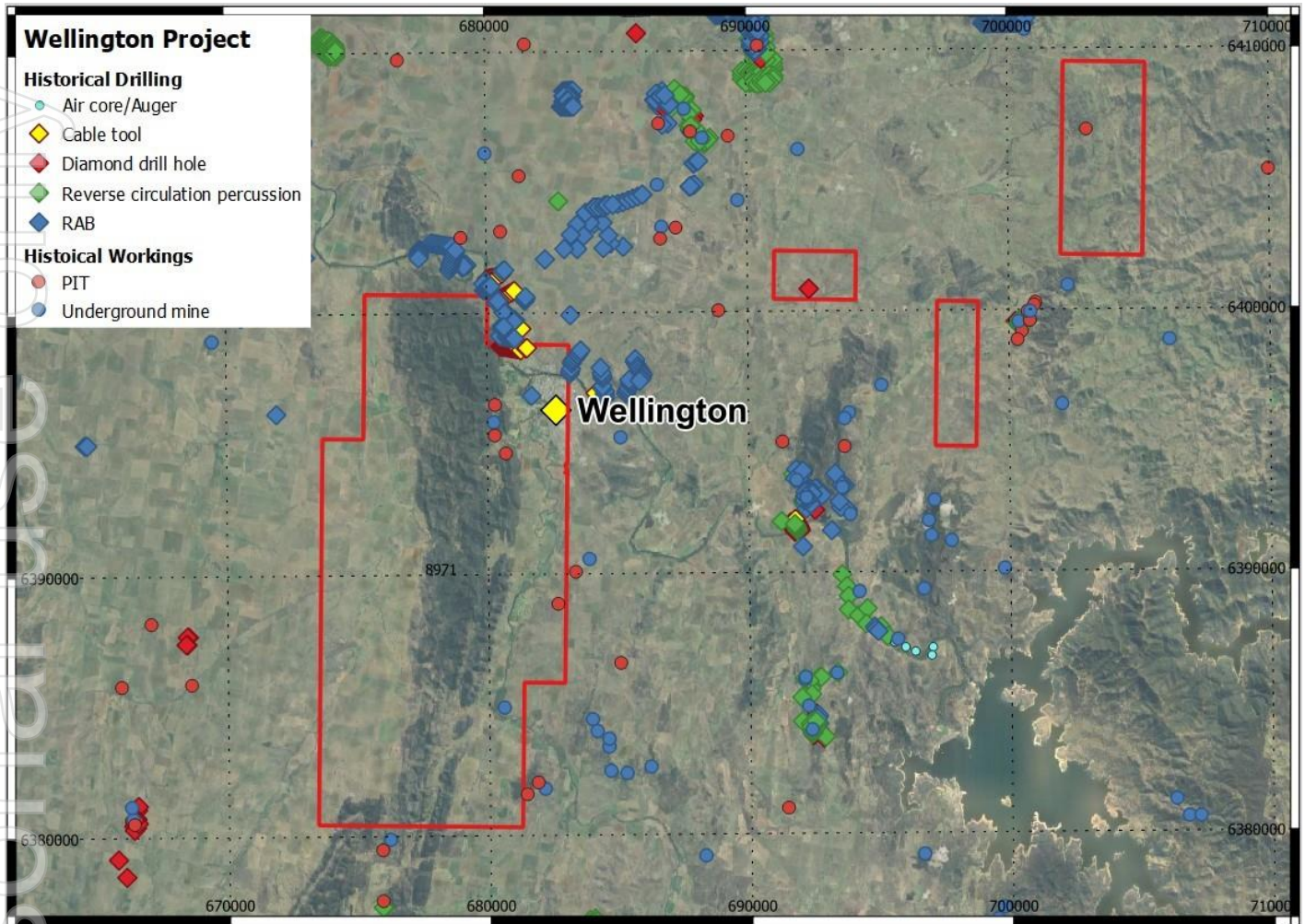

**Figure 7.** NSW MinView plan showing historic drilling

\*Alkane Resources Ltd ASX announcement Annual Resources and Reserves Statement FY24-4 September 2024

**Tindery Gold Project (EL 8579), Cobar, NSW, 100% KFM**

The tenement lies on the eastern margin of the Cobar Basin which is part of a larger Siluro-Devonian rift system. Most of the area is underlain by highly deformed and metamorphosed siltstones, sandstones, conglomerates and cherts of the Girilambone Group. These are intruded by muscovite-biotite granites of the Tinderra Granite.

For personal use only

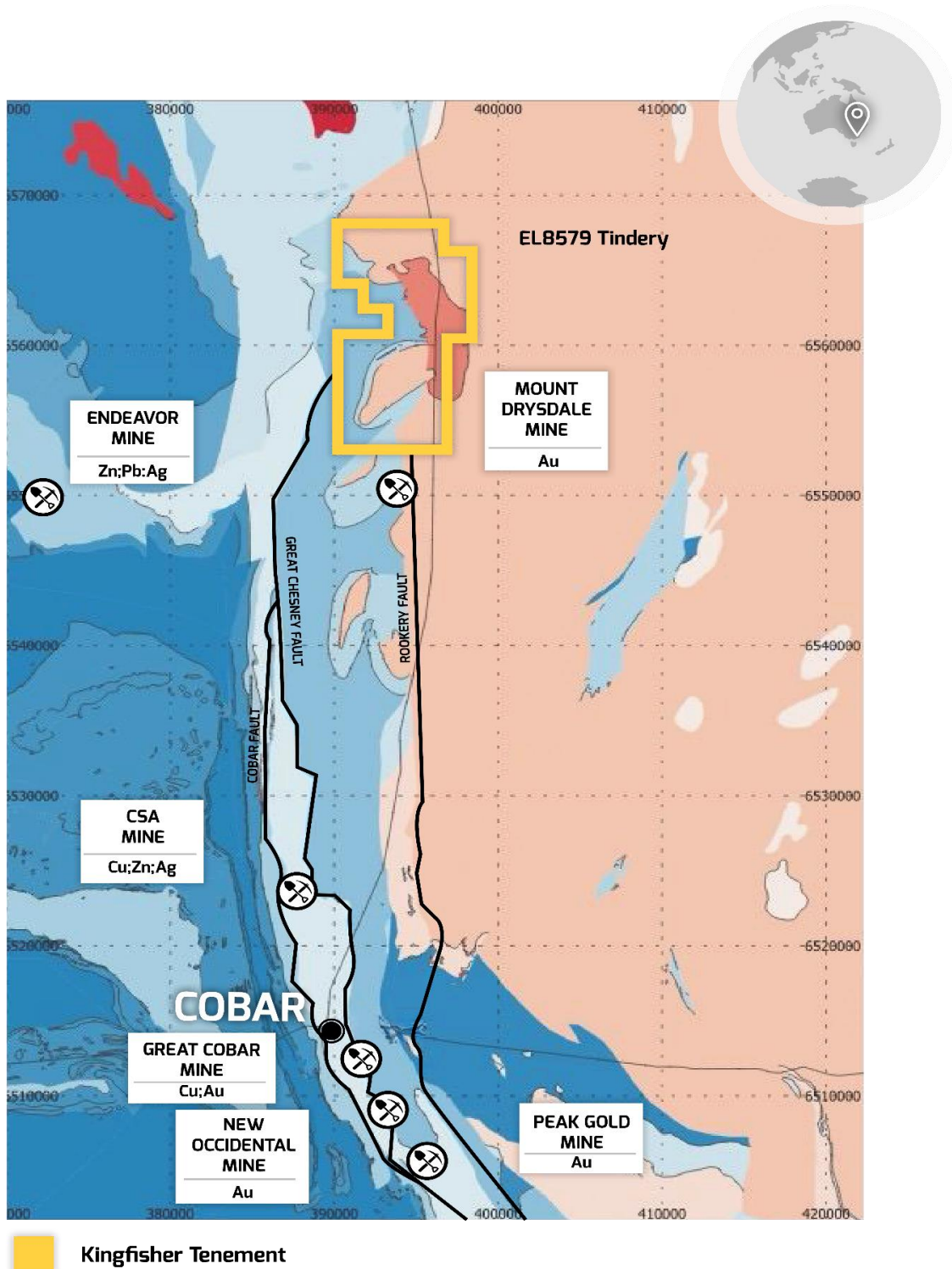
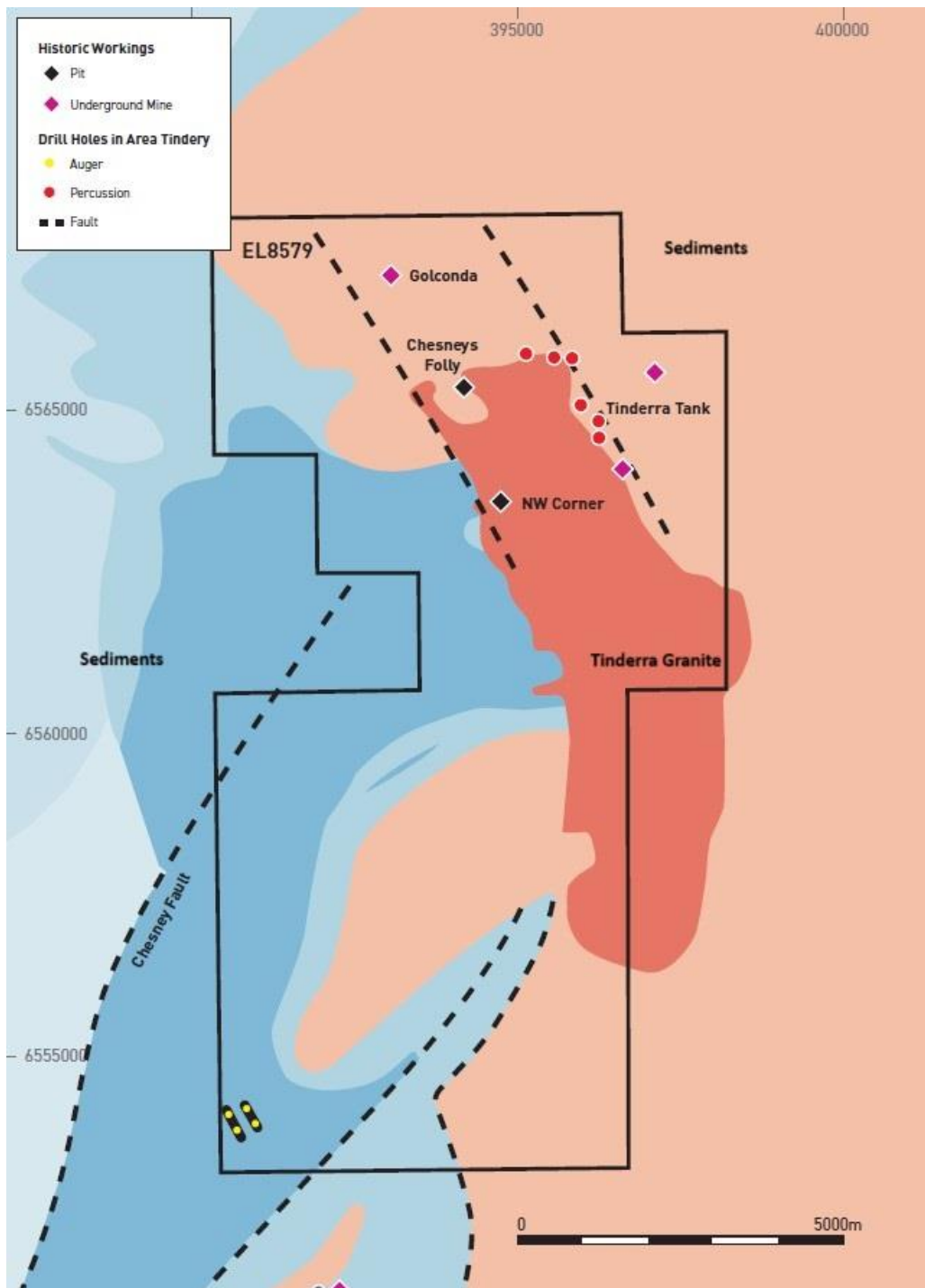

**Figure 8.** Tindery Location Plan (base plan from NSW MinView).

A number of significant gold occurrences are present south of the tenure on the Chesney Fault which strikes into the southern part of EL8579. There are a number of faults within the tenement which are considered prospective for evaluation for gold mineralisation.

These include the historic Golconda mine, with historic mines department records stating that three shafts (depths 30, 70 and 80ft) were sunk in 1905 on "lines of reef" which appear to parallel the cleavage, and strike at 225 to 235 magnetic. The main line of old workings "lies in a 50m wide zone of discontinuous alteration", this is where a 50m wide up to 300m striking zone of quartz stockwork is present within chlorite altered sediments and has not been drill tested. Samples from historic dumps at Golconda graded as high as 2.5ppm Au.

Limited Drilling in the north-east of the tenement is concentrated over the gold occurrences of Chesneys Folly and Tinderra Tank. The Tinderra Tank prospect was RAB drill tested by Dominion in 1993 with peak gold values of 0.83 ppm. A water bore drilled by CSA was completed in 2018 and sampled by SCI however no significant results were returned. The Golconda mine which does not appear to have been drilled and the Chesney's Folly prospect present opportunities for drill testing following further soil geochemistry and on ground assessment.



**Figure 9.** Tindery tenement plan with prospects and historic drilling (base plan from NSW MinView).

### Next steps

Kingfisher plans to immediately commence landholder and stakeholder engagement in advance of on ground field assessment and follow-up exploration programs. The immediate focus will be on prioritising near-term drill targets across the Projects but with particular focus on the Copper Blow prospect where there is the nearest term potential for the generation of a JORC compliant Mineral Resource Estimate.

For personal use only

This announcement has been authorised by the Board of Directors of the Company.

**Ends****For further information, please contact:****Kingfisher Mining Limited**

Scott Huffadine Non-Executive Chairman Ph: +61 (08) 9481 0389

E: [info@kingfishermining.com.au](mailto:info@kingfishermining.com.au)

**About Kingfisher Mining Limited**

Kingfisher Mining Limited (ASX:KFM) is a mineral exploration company committed to increasing value for shareholders through the acquisition, exploration and development of mineral resource projects throughout Australia. The Company's NSW tenure covers approximately 700km<sup>2</sup> with a portfolio of early stage and advanced Copper-Gold and Silver-Lead-Zinc projects, over 3 proven mining districts. The Western Australian tenements cover 938km<sup>2</sup> in the underexplored Gascoyne Mineral Field.

The Company has made a number of breakthrough high grade rare earth elements discoveries in the Gascoyne region where it holds a target strike lengths of more than 54km along the Chalba mineralised corridor and more than 30km along the Lockier mineralised corridor.

To learn more please visit: [www.kingfishermining.com.au](http://www.kingfishermining.com.au)

**Forward-Looking Statements**

This announcement may contain forward-looking statements which involve a number of risks and uncertainties. These forward-looking statements are expressed in good faith and believed to have a reasonable basis. These statements reflect current expectations, intentions or strategies regarding the future and assumptions based on currently available information. Should one or more of the risks or uncertainties materialise, or should underlying assumptions prove incorrect, actual results may vary from the expectations, intentions and strategies described in this announcement. No obligation is assumed to update forward looking statements if these beliefs, opinions, and estimates should change or to reflect other future developments.

**Competent Persons Statements**

The information in this report that relates to exploration results, is based on and fairly represents information reviewed and compiled by Mr Scott Huffadine BSc (Hons), MAIG, Non-Executive Chairman and an employee of Kingfisher Mining Limited, who is a Member of the Australian Institute of Geoscientists. Mr Huffadine has sufficient experience, which is relevant to the exploration activities, style of mineralisation and types of deposits under consideration, and to the activity which has been undertaken, to qualify as a Competent Person as defined in the 2012 Edition of the "Australasian Code for Reporting of Exploration Results, Mineral Resources and Ore Reserves". Mr Huffadine is a Non-Executive Director of Kingfisher Mining Limited and consents to the inclusion in this announcement of the matters based on their information in the form and context in which it appears.

**Assay table**
**Table 1**

Copper Blow													
Hole ID	Hole_Type	Easting	Northing	RL	Dip (Degr)	Azimuth (Degrees)	End of Hole Depth (m)	Depth_From (m)	Depth_To (m)	Interval (m)	Cu (%)	Au (g/t)	
17CB041	RC	547619	6445039	236	-60	145.0	204	188	192	4	6.13	4.23	
17CB043	RCD	547700	6445166	235	-61	144.2	375.8	131.78	140	8.22	1.87	0.53	
17CB045	RC	547739	6445117	235	-59	144.2	216	126	133	7	3.7	1.07	
17CB048	RC	547894	6445245	235	-60	141.9	198			78	0.4	0.1	
							inc.			5	1.2	0.4	
							inc.			9	1	0.3	
84DDHCB	DD	547865	6445286	234	-60	144.9	246.7	133	149	16	2.67	0.62	
84DDHCB	DD	547865	6445286	234	-60	144.9	246.7	177	181	4	3.48	2.39	
18CB054	DD	548016	6445066	234	-60	325.0	404.8	154	230	76	0.74	0.23	
							inc.	183.8	225	41.2	1.27	0.4	
							inc.	189	215	27	1.65	0.5	
							inc.	189	196	7	2.23	0.99	
							inc.	208	215	7	1.97	0.48	
18CB057	RCD	547652	6445066	235	-60	146.0	303	278	289	22	1.08	0.31	
							inc.	285	300	15	1.31	0.32	
CBRC005	RC	547947	6445183	237	-60	145.5	70			18	0.7	0.3	
							inc.			6	1	0.4	
CBRC006	RC	547931	6445204	237	-60	145.5	80			48	0.85	0.1	
										8	1.6	0.3	
CBRC007	RC	547903	6445220	236	-60	145.5	110			80	0.6	0.2	
							inc.			10	1.4	0.34	
Allendale													
Hole ID	Hole_Type	Northing	Easting	RL	Dip (Degr)	Azimuth (Degrees)	End of Hole Depth (m)	Depth_From (m)	Depth_To (m)	Interval (m)	Ag (g/t)	Pb (%)	Zn (%)
RCAN002	RC	6503097	545709	363	-90	0	40	15	25	10	29	4.1	12
							inc.	15	16	1	80.1	12.0	26.3
							inc.	18	20	2	43.3	6.4	27.4
RCAN011	RC	6503418	545775	356	-70	273.5	85	47	49	2	39.9	8.4	11.4
RCAN016	RC	6503022	545764	370	-80	273.5	145	117	119	2	51.1	6.2	7.6
RCAN019	RC	6502946	545750	370	-60	273.5	121	53	55	2	44.3	5.0	6.8
							and	78	81	3	31	4.0	9.2

**References****Copper Blow and Broken Hill**

Exploration Report, ELs 1376,1990, 2072 and various PLs, Galena Hill–Mt Gipps, Broken Hill area, Shell Company of Australia Ltd, 1984, [geoscience.nsw.gov.au/report/R00012186](https://www.geoscience.nsw.gov.au/report/R00012186)

Exploration report, EL3850, Broken Hill, The Pinnacles area, Triako Resources Ltd, 1993, [geoscience.nsw.gov.au/report/R00001469](https://www.geoscience.nsw.gov.au/report/R00001469)

Eleventh Annual Exploration Report, EL4632, Broken Hill Area, Triako Resources Ltd, 2005, [geoscience.nsw.gov.au/report/R00043287](https://www.geoscience.nsw.gov.au/report/R00043287)

Annual Report 13th on EL 4632, Rupee and Copper Blow JV Project, covering the period from 21 December 2005 to 20 December 2006. Triako Resources Ltd, 2006, [geoscience.nsw.gov.au/report/R00041440](https://www.geoscience.nsw.gov.au/report/R00041440)

Fitzherbert and Downes. 2018. A Mineral System Model for shear-hosted iron oxide–copper–gold (IOCG) mineralisation in the Broken Hill Block, with a focus on Copper Blow. Geological Survey of New South Wales. GS2018/0371.

Barnes R.G. 1988. Metallogenic studies of the Broken Hill and Euriovie Blocks, New South Wales. 1. Styles of Mineralisation in the Broken Hill Block. 2. Mineral Deposits of the Southwestern Broken Hill Block. *New South Wales Geological Survey – Bulletin 32* (1,2). 250 pp.

SCI:ASX, Public Report, 27 March 2017, Excellent Results from Preliminary Metallurgy at Copper Blow.

SCI:ASX, Public Report, 10 October 2017, Exploration Commenced on 6km Strike extension at Copper Blow.

SCI:ASX, Public Report, 12 June 2018, New Copper–Gold Targets expand Copper Blow.

SCI:ASX, Public Report, 5 July 2018, Copper–Gold intersections at Copper Blow.

SCI:ASX, Public Report, 17 September 2018, New Copper–Cobalt projects at Broken Hill.

SCI:ASX, Public Report, 17 October 2017, Copper–Cobalt Belt over 25km strike near Broken Hill.

SCI:ASX, Public Report, 5 February 2018, Copper Sulphide Intersections at Copper Blow.

SCI:ASX, Public Report, 22 February 2018, Excellent Copper Intersection at Copper Blow.

SCI:ASX, Public Report, 5 October 2017, High Grade Copper–Gold (Silver–Cobalt) in first RC hole at Copper Blow.

Diamond drilling, A to P 3084, Allendale Mine, Purnamoota, North Broken Hill Ltd, 1970, [geoscience.nsw.gov.au/report/R00027619](https://www.geoscience.nsw.gov.au/report/R00027619)

SCI:ASX, Public Report, 27 September 2011, Multiple High Grade intersections at Allendale, near Broken Hill, NSW.

**Wellington**

Drilling at Willunga Cu–Mo Prospect EL 74, Wellington, Placer Prospecting Pty Ltd, 1967, [geoscience.nsw.gov.au/report/R00027699](https://www.geoscience.nsw.gov.au/report/R00027699)

Exploration Report Wellington Area EL74, Placer Prospecting Pty Ltd, 1968, [geoscience.nsw.gov.au/report/R00028170](https://www.geoscience.nsw.gov.au/report/R00028170)

SCI:ASX, Public Report, 16 April 2020, Significant 1.2km Copper anomaly identified at the Wellington Project located 15km from the BODA discovery.

Alkane Resources Ltd ASX announcement Annual Resources and Reserves Statement FY24–4 September 2024

Harris, Cooke, Cuisson, Groome, Wilson, Fox, Holliday, Tosdal., 2020. Geologic Evolution of Late Ordovician to Early Silurian Alkalic Porphyry Au–Cu Deposits at Cadia, New South Wales, Australia, CODES

Regis Resources 2023., Annual Mineral Resource and Ore Reserve Statement 20 June 2023

Evolution 2023, <https://evolutionmining.com.au/reservesresources/>

Evolution 2024, Cowal Site Visit Presentation, 20 June 2024, ASX

Evolution Mining Limited. (2024). Annual mineral resources and ore reserves statement as at 31 December 2023. <https://evolutionmining.com.au/wp-content/uploads/2024/02/2680687-Annual-MineralResources-and-Ore-Reserves-Statement.pdf>

**Tindery**

First annual exploration report EL 4620 Cobar, Dominion Mining Ltd 1993, [geoscience.nsw.gov.au/report/R00001328](http://geoscience.nsw.gov.au/report/R00001328)  
Sixth Annual and Final Exploration Report on EL6415 - Tindarey Project, Covering Period 17 May 2010 to 16 May 2011, Robust Resources Ltd, 2011, [geoscience.nsw.gov.au/report/RE0001647](http://geoscience.nsw.gov.au/report/RE0001647).  
SC:ASX, Public Report, 19 August 2020, Exploration work to commence on 2.5 km gold strike at Tindery Project in NSW.  
Glenn Coianiz. Evaluation of Remotely Sensed data for the Tindery and Wilga Downs project areas, Cobar. NSW. Exploris Pty Ltd  
First and Final report, EL 3124, Girilambone, Coolabah area Pakrac Holdings Pty Ltd 1988, [geoscience.nsw.gov.au/report/R00005224](http://geoscience.nsw.gov.au/report/R00005224)

For personal use

Attachment 1: JORC Code, 2012 Edition – Table 1  
Section 1 Sampling Techniques and Data

Criteria	JORC Code explanation	Commentary
<b>Sampling techniques</b>	<ul style="list-style-type: none"> <li>Nature and quality of sampling (eg cut channels, random chips, or specific specialised industry standard measurement tools appropriate to the minerals under investigation, such as down hole gamma sondes, or handheld XRF instruments, etc). These examples should not be taken as limiting the broad meaning of sampling.</li> <li>Include reference to measures taken to ensure sample representivity and the appropriate calibration of any measurement tools or systems used.</li> <li>Aspects of the determination of mineralisation that are Material to the Public Report.</li> <li>In cases where 'industry standard' work has been done this would be relatively simple (eg 'reverse circulation drilling was used to obtain 1 m samples from which 3 kg was pulverised to produce a 30 g charge for fire assay'). In other cases more explanation may be required, such as where there is coarse gold that has inherent sampling problems. Unusual commodities or mineralisation types (eg submarine nodules) may warrant disclosure of detailed information.</li> </ul>	<ul style="list-style-type: none"> <li>Historical drilling is detailed in exploration reports with drilling undertaken by companies after 2012 also detailed in Public Reports.</li> <li>Historic Rock chip stream sediment and costean sampling is detailed in historical exploration reports sourced from the NSW DIGS database and the vendor supplied database.</li> <li>RAB and cable drilling programs and results are referenced however it is not considered to be a reliable methodology for detailed analysis and is used for first pass reconnaissance. The results referred to are to provide context in relation to the historic work that has been undertaken on the projects.</li> </ul>
<b>Drilling techniques</b>	<ul style="list-style-type: none"> <li>Drill type (eg core, reverse circulation, open-hole hammer, rotary air blast, auger, Bangka, sonic, etc) and details (eg core diameter, triple or standard tube, depth of diamond tails, face-sampling bit or other type, whether core is oriented and if so, by what method, etc).</li> </ul>	<ul style="list-style-type: none"> <li>Historical drilling was completed by Auger, RAB, RC and diamond drilling methods at the Broken Hill project.</li> <li>Historical drilling was completed by RAB and auger drilling over the Tindery tenement area, and a RC water bore completed for CSA.</li> <li>Historical drilling was completed by diamond, RAB and cable drill drilling methods over the Wellington project.</li> </ul>
<b>Drill sample recovery</b>	<ul style="list-style-type: none"> <li>Method of recording and assessing core and chip sample recoveries and results assessed.</li> <li>Measures taken to maximise sample recovery and ensure representative nature of the samples.</li> </ul>	<ul style="list-style-type: none"> <li>Recovery data from drilling in more recent times is detailed in Public Reports and describes recovery for diamond to be very high 95-100% and no issues noted re the RC drilling.</li> </ul>

Criteria	JORC Code explanation	Commentary
	<ul style="list-style-type: none"> <li>Whether a relationship exists between sample recovery and grade and whether sample bias may have occurred due to preferential loss/gain of fine/coarse material.</li> </ul>	<ul style="list-style-type: none"> <li>Broken Hill: A number of diamond holes from Copper Blow and 2 holes from Allendale were viewed by a Company Representative in a vendor storage facility and at the EC Andrews Core library in Broken Hill. Core recoveries were noted to have been good with no major core loss noted in the holes inspected.</li> <li>Core that was visually assessed was adjudged to have been cut in half and a consistent half of the core taken (5 holes)</li> <li>Either insufficient or no recovery data is available for historic drilling from exploration reports.</li> </ul>
<b>Logging</b>	<ul style="list-style-type: none"> <li>Whether core and chip samples have been geologically and geotechnically logged to a level of detail to support appropriate Mineral Resource estimation, mining studies and metallurgical studies.</li> <li>Whether logging is qualitative or quantitative in nature. Core (or costean, channel, etc) photography.</li> <li>The total length and percentage of the relevant intersections logged.</li> </ul>	<ul style="list-style-type: none"> <li>Historical logging, where available from exploration reports were reviewed.</li> <li>Logging methodology for recent RC and diamond Drilling is contained in Table 1's from public reports referenced in this Report</li> </ul>
<b>Sub-sampling techniques and sample preparation</b>	<ul style="list-style-type: none"> <li>If core, whether cut or sawn and whether quarter, half or all core taken.</li> <li>If non-core, whether riffled, tube sampled, rotary split, etc and whether sampled wet or dry.</li> <li>For all sample types, the nature, quality and appropriateness of the sample preparation technique.</li> <li>Quality control procedures adopted for all sub-sampling stages to maximise representivity of samples.</li> <li>Measures taken to ensure that the sampling is representative of the in situ material collected, including for instance results for field duplicate/second-half sampling.</li> </ul>	<ul style="list-style-type: none"> <li>Sampling methodology is not documented in all historic reports.</li> <li>Sampling methodology for recent RC and diamond drilling in the Broken Hill projects is contained in Table 1's from public reports referenced in this Report and appears to be consistent with current industry best practice.</li> </ul>

Criteria	JORC Code explanation	Commentary
	<ul style="list-style-type: none"> <li>Whether sample sizes are appropriate to the grain size of the material being sampled.</li> </ul>	
<b>Quality of assay data and laboratory tests</b>	<ul style="list-style-type: none"> <li>The nature, quality and appropriateness of the assaying and laboratory procedures used and whether the technique is considered partial or total.</li> <li>For geophysical tools, spectrometers, handheld XRF instruments, etc, the parameters used in determining the analysis including instrument make and model, reading times, calibrations factors applied and their derivation, etc.</li> <li>Nature of quality control procedures adopted (eg standards, blanks, duplicates, external laboratory checks) and whether acceptable levels of accuracy (ie lack of bias) and precision have been established.</li> </ul>	<ul style="list-style-type: none"> <li>Samples from recent drilling at Broken Hill are detailed in Public Reports referenced in this report. They were analysed by ALS for 35 elements including base metals was aqua regia ICP-AES and gold by 30g Fire Assay with AA finish. (ALS Global codes ME-ICP41 and OG46 and Au-AA25.</li> <li>In recent drilling post 2012, CRM standards are inserted every 40<sup>th</sup> sample as well as lab standards. Duplicates were taken for RC drilling.</li> <li>Sampling methodology and information is not documented in all historic reports for Tindery and Wellington.</li> <li>Historical assaying techniques and QAQC methodology coupled with the uncertainty of sampling methodology is not considered to be reliable.</li> </ul>
<b>Verification of sampling and assaying</b>	<ul style="list-style-type: none"> <li>The verification of significant intersections by either independent or alternative company personnel.</li> <li>The use of twinned holes.</li> <li>Documentation of primary data, data entry procedures, data verification, data storage (physical and electronic) protocols.</li> <li>Discuss any adjustment to assay data.</li> </ul>	<ul style="list-style-type: none"> <li>Significant intersections reported from Copper Blow and Allendale were taken from exploration and public reports to the ASX and cross checked against the vendor supplied database during due diligence.</li> <li>Intervals were calculated at both an 0.1 and 0.5% copper lower cut for inclusion.</li> <li>Information from historical reports is presented without adjustment as detailed in Exploration reports submitted to NSW government as per tenement conditions.</li> <li>No holes have been twinned</li> <li>No adjustments have been made to any assay data</li> </ul>
<b>Location of data points</b>	<ul style="list-style-type: none"> <li>Accuracy and quality of surveys used to locate drill holes (collar and down-hole surveys), trenches, mine workings and other locations used in Mineral Resource estimation.</li> <li>Specification of the grid system used.</li> <li>Quality and adequacy of topographic control.</li> </ul>	<ul style="list-style-type: none"> <li>As part of the due diligence at the Broken Hill project, a company representative assessed 27 drill hole locations from the vendor supplied database using a handheld GPS using the UTM coordinate system, with an accuracy of +/-10m.</li> <li>All holes visited were in approximately the right location stated in the database based on a margin of error given the utilisation of a</li> </ul>

Criteria	JORC Code explanation	Commentary
		<p>handheld GPS unit. This is only a small sample set and is not represented as validating all historic drilling, but the random nature of the sites visited, was sufficient level of confidence in the data provided.</p> <ul style="list-style-type: none"> <li>• This is only a small sample set and is not represented as validating all historic drilling.</li> <li>• The Company has not sighted any historic drill collars at either Tindery or Welling ton with data taken from historical reports</li> <li>• Drill collars data was also reviewed in the NSW MinView spatial data platform.</li> <li>• Details of recent drilling (2017-2018) at Copper Blow are detailed in Public Reports and were surveyed using a DGPS system in MGA94 Zone 54</li> <li>• Accurate topographic surveys over Copper Blow have been completed by drone.</li> </ul>
<b>Data spacing and distribution</b>	<ul style="list-style-type: none"> <li>• <i>Data spacing for reporting of Exploration Results.</i></li> <li>• <i>Whether the data spacing and distribution is sufficient to establish the degree of geological and grade continuity appropriate for the Mineral Resource and Ore Reserve estimation procedure(s) and classifications applied.</i></li> <li>• <i>Whether sample compositing has been applied.</i></li> </ul>	<ul style="list-style-type: none"> <li>• Data spacing from exploration reports is considered sufficient for early-stage exploration.</li> <li>• Data spacing at Copper Blow could be considered sufficient and appropriate for the purposes of Mineral Resource Estimation.</li> <li>• There is no Mineral Resource estimate complete on any of the tenements.</li> </ul>
<b>Orientation of data in relation to geological structure</b>	<ul style="list-style-type: none"> <li>• <i>Whether the orientation of sampling achieves unbiased sampling of possible structures and the extent to which this is known, considering the deposit type.</i></li> <li>• <i>If the relationship between the drilling orientation and the orientation of key mineralised structures is considered to have introduced a sampling bias, this should be assessed and reported if material.</i></li> </ul>	<ul style="list-style-type: none"> <li>• Drilling of Allendale and Copper Blow where historic assays are reported appear to be perpendicular to the strike of the mineralising structures.</li> <li>• N/A for all other projects</li> </ul>
<b>Sample security</b>	<ul style="list-style-type: none"> <li>• <i>The measures taken to ensure sample security.</i></li> </ul>	<ul style="list-style-type: none"> <li>• N/A</li> </ul>

Criteria	JORC Code explanation	Commentary
<b>Audits or reviews</b>	<ul style="list-style-type: none"> <li>The results of any audits or reviews of sampling techniques and data.</li> </ul>	<ul style="list-style-type: none"> <li>N/A</li> </ul>

## Section 2 Reporting of Exploration Results

Criteria	JORC Code explanation	Commentary
<b>Mineral tenement and land tenure status</b>	<ul style="list-style-type: none"> <li>Type, reference name/number, location and ownership including agreements or material issues with third parties such as joint ventures, partnerships, overriding royalties, native title interests, historical sites, wilderness or national park and environmental settings.</li> <li>The security of the tenure held at the time of reporting along with any known impediments to obtaining a licence to operate in the area.</li> </ul>	<ul style="list-style-type: none"> <li>EL8579 Tindery is located near Cobar in NSW, the tenement is owned 100% by Austin Metals Ltd and will be transferred to Kingfisher Mining Ltd as part of the contemplated acquisition.</li> <li>EL8971 Wellington is located in NSW, the tenement is owned 100% by Austin Metals Ltd and will be transferred to Kingfisher Mining Ltd as part of the contemplated acquisition.</li> <li>EL's 8077,8078 and 8495 are owned 100% by Austin Metals Ltd and will be transferred to Kingfisher Mining Ltd as part of the contemplated acquisition.</li> <li>Austin Metals beneficially owns EL7300 (85%), and EL's 8075, 8236, 8862 and 8863 (75%) in a Joint Venture with Broken Hill Mines Pty Ltd. Austin Metals beneficial interest in the above tenements and will be transferred to Kingfisher Mining Ltd as part of the contemplated acquisition.</li> <li>ELs 8862,8863, 8075, 8077 and 8078 all have renewal applications lodged and are currently undergoing assessment.</li> <li>Landholder access agreements have been in place over the Broken Hill tenements. Evidence of access to the Tindery prospect is contained with Exploration reports</li> </ul>
<b>Exploration done by other parties</b>	<ul style="list-style-type: none"> <li>Acknowledgment and appraisal of exploration by other parties.</li> </ul>	<ul style="list-style-type: none"> <li>Exploration activities conducted historically by other parties is referenced in the body of the announcement and is sourced via the NSW DIGS and MinView online databases and public reports available on the ASX platform.</li> </ul>



**P** +61 9481 0389  
**E** info@kingfishermining.com.au  
**W** www.kingfishermining.com.au/

**A** Unit 2, 106 Robinson Avenue  
 Belmont WA 6104 AUSTRALIA  
**ABN** 96 629 675 216

**Investor Centre**

Criteria	JORC Code explanation	Commentary
<b>Geology</b>	<ul style="list-style-type: none"> <li>• <i>Deposit type, geological setting and style of mineralisation.</i></li> </ul>	<ul style="list-style-type: none"> <li>• Copper Blow: Iron Oxide Copper Gold (IOCG) deposits</li> <li>• Wellington: Porphyry Copper style copper gold targets in the Macquarie Volcanic Arc.</li> <li>• Tindery: Intrusion related gold deposits in and around Silurian sediments and Ordovician granites.</li> <li>• Broken Hill style Ag-Pb-Zn deposits</li> </ul>
<b>Drill hole Information</b>	<ul style="list-style-type: none"> <li>• <i>A summary of all information material to the understanding of the exploration results including a tabulation of the following information for all Material drill holes:</i> <ul style="list-style-type: none"> <li>○ <i>easting and northing of the drill hole collar</i></li> <li>○ <i>elevation or RL (Reduced Level – elevation above sea level in metres) of the drill hole collar</i></li> <li>○ <i>dip and azimuth of the hole</i></li> <li>○ <i>down hole length and interception depth</i></li> <li>○ <i>hole length.</i></li> </ul> </li> <li>• <i>If the exclusion of this information is justified on the basis that the information is not Material and this exclusion does not detract from the understanding of the report, the Competent Person should clearly explain why this is the case.</i></li> </ul>	<ul style="list-style-type: none"> <li>• Drillhole data is sourced from the vendor supplied database as well as historical exploration reports accessed via the NSW DIGS and MinView online databases.</li> <li>• Location, orientation and depth data are tabulated for historic significant intersections included in this announcement. Data source from Vendor supplied database and Public Reports</li> </ul>
<b>Data aggregation methods</b>	<ul style="list-style-type: none"> <li>• <i>In reporting Exploration Results, weighting averaging techniques, maximum and/or minimum grade truncations (eg cutting of high grades) and cut-off grades are usually Material and should be stated.</i></li> <li>• <i>Where aggregate intercepts incorporate short lengths of high grade results and longer lengths of low grade results, the procedure used for such aggregation should be stated and some typical examples of such aggregations should be shown in detail.</i></li> <li>• <i>The assumptions used for any reporting of metal equivalent values should be clearly stated.</i></li> </ul>	<ul style="list-style-type: none"> <li>• No top cuts are applied.</li> <li>• Refer to Public Reports for Copper Blow and Allendale as referenced.</li> <li>• Reported assays were checked using vendor supplied database by calculating a length weighted average at a lower cut off of 0.1%Cu and 0.5% Cu. Gold assays reported are the length weighted average within the primary copper interval.</li> <li>• No metal equivalents are reported</li> </ul>

Criteria	JORC Code explanation	Commentary
<b>Relationship between mineralisation widths and intercept lengths</b>	<ul style="list-style-type: none"> <li>• These relationships are particularly important in the reporting of Exploration Results.</li> <li>• If the geometry of the mineralisation with respect to the drill hole angle is known, its nature should be reported.</li> <li>• If it is not known and only the down hole lengths are reported, there should be a clear statement to this effect (eg 'down hole length, true width not known').</li> </ul>	<ul style="list-style-type: none"> <li>• Downhole interval reported, no calculation or representation of the estimated true widths are presented</li> </ul>
<b>Diagrams</b>	<ul style="list-style-type: none"> <li>• Appropriate maps and sections (with scales) and tabulations of intercepts should be included for any significant discovery being reported. These should include, but not be limited to a plan view of drill hole collar locations and appropriate sectional views.</li> </ul>	<ul style="list-style-type: none"> <li>• Appropriate maps and diagrams have been included given the nature and context of this announcement being an acquisition of a significant portfolio of tenements over 3 different and spatially distributed project areas.</li> </ul>
<b>Balanced reporting</b>	<ul style="list-style-type: none"> <li>• Where comprehensive reporting of all Exploration Results is not practicable, representative reporting of both low and high grades and/or widths should be practiced to avoid misleading reporting of Exploration Results.</li> </ul>	<ul style="list-style-type: none"> <li>• Given the significant exploration history on the projects in aggregate it is not considered practicable to report all historic exploration results</li> <li>• Historic results reported are consistent as per exploration reports by others, no interpretation or modifications have been made by the company.</li> </ul>
<b>Other substantive exploration data</b>	<ul style="list-style-type: none"> <li>• Other exploration data, if meaningful and material, should be reported including (but not limited to): geological observations; geophysical survey results; geochemical survey results; bulk samples – size and method of treatment; metallurgical test results; bulk density, groundwater, geotechnical and rock characteristics; potential deleterious or contaminating substances.</li> </ul>	<ul style="list-style-type: none"> <li>• N/A</li> </ul>
<b>Further work</b>	<ul style="list-style-type: none"> <li>• The nature and scale of planned further work (eg tests for lateral extensions or depth extensions or large-scale step-out drilling).</li> <li>• Diagrams clearly highlighting the areas of possible extensions, including the main geological interpretations and future drilling areas, provided this information is not commercially sensitive.</li> </ul>	<ul style="list-style-type: none"> <li>• On ground exploration activities are planned and will be the subject of entering into landholder access agreements many of which have lapsed and need to be renewed.</li> </ul>