

31 July 2025

ASX Announcement

## Quarterly Activities Report

Kingfisher Mining Limited (**ASX:KFM**) ("**Kingfisher**" or the "**Company**") is pleased to present the quarterly activities report for period ending 30 June 2025.

### Highlights:

- Subsequent to end of the quarter KFM entered into a Binding Agreement with Austin Metals Ltd (ASX:AYT) ("Austin") for the acquisition of a portfolio of early stage to advanced Copper-Gold, Gold and Silver Lead Zinc projects located in the Broken Hill (incl. Copper Blow copper-gold and West Broken Hill zinc-lead-silver), Cobar (Tindery gold-base metals) and within the Macquarie Arc (Wellington copper-gold) regions in NSW
- KFM believes the acquisition represents significant value for Kingfisher shareholders, with a total consideration of \$200,000 in cash and \$200,000 in Kingfisher shares to be issued to Austin upon completion
- Copper Blow is interpreted as an IOCG project with historical high grade copper, gold and silver assays including,
  - 16m @ 2.67% Cu, 0.62 g/t Au and 4.04 g/t Ag from 133m in 84DDHCB06
  - 4m @ 6.13% Cu, 4.23 g/t Au and 12.93 g/t Ag from 188m in 17CB041
  - 7m @ 3.7% Cu, 1.07 g/t Au and 5.5 g/t Ag from 126m in 17CB045
  - 4m @ 3.48% Cu, 2.39 g/t Au and 5.9 g/t Ag from 177m in 84DDHCB06
- Broken Hill West consists of multiple Ag-Pb-Zn prospects which includes historical intercepts of:
  - 10m@16.1% Pb+Zn and 29 g/t Ag from 15m in RCAN002
  - 2m@ 19.9% Pb+Zn and 39.2 g/t Ag from 47m in RCAN011
  - 2m@ 13.8% Pb+Zn and 51.1 g/t Ag from 117m in RCAN016
  - 3m @ 13.2% Pb+Zn and 31.0g/t from 78m in RCAN019
- Wellington Project located in the Macquarie Arc, the key prospect is Willunga located 15km away from the Boda/Kaiser porphyry-copper deposit.
- Subsequent to the end of the quarter the Company announced a capital raising and rights issues to raise a total of \$1,854,400 (before costs) through a placement to sophisticated and professional investors and a subsequent non-renounceable entitlement issue to eligible shareholders..
- Closing cash and listed investment as of 30 June 2025 was \$1.627M, comprising \$1.472M cash and listed investments of \$0.155M \*.

\*Based on BC8 closing share price on 30 June 2025.

Kingfisher's Non-Executive Chairman Scott Huffadine commented:

"The acquisition of this portfolio of projects from Austin we believe represents a compelling value proposition to Kingfisher with exploration upside over numerous Copper-gold and Lead-Zinc-silver projects proximal to a number of world class deposits in three proven mining districts in NSW, whilst still providing the option value on the Gascoyne Rare Earth project in Western Australia. Many of the projects already have historical high grade intercepts."

## QUARTERLY ACTIVITIES

During the quarter the Company continued to source and review a number of opportunities to extend and diversify its portfolio in addition to its REE and Lithium prospects. Numerous opportunities predominately Gold and Copper continue to be assessed.

## NSW portfolio acquisition

Subsequent to the end of the quarter Kingfisher entered into a Binding Agreement with Austin Metals Ltd (**ASX:AYT**) ("**Austin**") for the acquisition of a portfolio of early stage to advanced Copper-Gold, Gold and Silver Lead Zinc projects located in the Broken Hill, Cobar and the Macquarie Arc regions in NSW (see KFM ASX announcement 25 July 2025). The tenement package comprising eleven tenements covering approximately 700 square kilometres in area.

These include:

- Copper Blow Iron Oxide Copper Gold (IOCG) Project (Broken Hill, NSW).
- Multiple Copper and Silver-Lead-Zinc prospects (Broken Hill, NSW).
- Wellington Copper Project (Macquarie Arc, NSW).
- Tindery Gold and base metal Project (Cobar, NSW).
- Copper Blow IOCG prospect hosts high grade copper gold mineralisation which has been defined by historical drilling over 600 metres of strike, historical drill results include:
  - **16m @ 2.67% Cu, 0.62 g/t Au and 4.04 g/t Ag from 133m in 84DDHCB06**
  - **4m @ 6.13% Cu, 4.23 g/t Au and 12.93 g/t Ag from 188m in 17CB041**
  - **7m @ 3.7% Cu, 1.07 g/t Au and 5.5 g/t Ag from 126m in 17CB045**
  - **4m @ 3.48% Cu, 2.39 g/t Au and 5.9 g/t Ag from 177m in 84DDHCB06**
  - **8.22m @ 1.87% Cu, 0.53 g/t Au and 3.09 g/t Ag from 131.78m in 17CB043**
  - **41.2m @ 1.27% Cu, 0.4 g/t Au and 1.53 g/t Ag from 183.8m inc. 7m @ 2.23% Cu and 0.99 g/t Au from 189m in 18CB054**
  - **22m @ 1.08% Cu, 0.31 g/t Au and 1.63 g/t Ag from 278m inc. 15m @ 1.31% Cu and 0.32 g/t Au from 285m in 18CB057**
- West Broken Hill, multiple Ag-Pb-Zn prospects, located NW of Broken Hill associated with historic mines which have seen significant historical exploration undertaken. High grade drill results from most recent drilling in 2011 at Allendale include:
  - **10m @ 16.1% Pb+Zn and 29 g/t Ag from 15m in RCAN002**
  - **2m @ 19.9% Pb+Zn and 39.2 g/t Ag from 47m in RCAN011**
  - **2m @ 13.8% Pb+Zn and 51.1 g/t Ag from 117m in RCAN016**
  - **3m @ 13.2% Pb+Zn and 31.0g/t from 78m in RCAN019**
- Wellington copper-gold Project located in the Macquarie Arc in NSW within favourable volcanic stratigraphy. The key asset is the Willunga prospect located 15km away from the Boda/Kaiser porphyry-copper deposit.

- Tindery Project located north of Cobar in NSW hosts a cluster of small historical gold workings with limited historic drilling at the northern end of the Chesney Fault, which is a major structural feature related to a number of economic deposits to the south near Cobar.

A summary of the key terms of the Agreement are set out below:

The Company will acquire a 100% of the legal and beneficial interest that the Vendor holds in:

- six (6) exploration licences, which the Vendor holds a 100% legal and beneficial interest in; and
- five (5) exploration licences, which the Vendor holds in joint-venture with third parties,

The consideration to the Vendor under the Acquisition Agreement will comprise:

- \$200,000 in cash; and
- subject to shareholder approval, that number of fully paid ordinary shares in the capital of the Company equal in value to \$200,000 calculated based on a deemed issue price equal to the 5-day VWAP prior to execution of the Acquisition Agreement (**Consideration Shares**), representing 4,000,000 Consideration Shares.

The Completion of the Acquisition Agreement is subject to satisfaction (or waiver) of a number of conditions precedent, including (but not limited to):

- the Company obtaining all require shareholder approvals to give effect to the transactions contemplated under the Acquisition Agreement, including (but not limited to) shareholder approval for the issue of the Consideration Shares;
- the Company and Vendor obtaining all necessary third-party approvals, consents and waivers (if any) to allow the parties to lawfully completion the Acquisition Agreement.

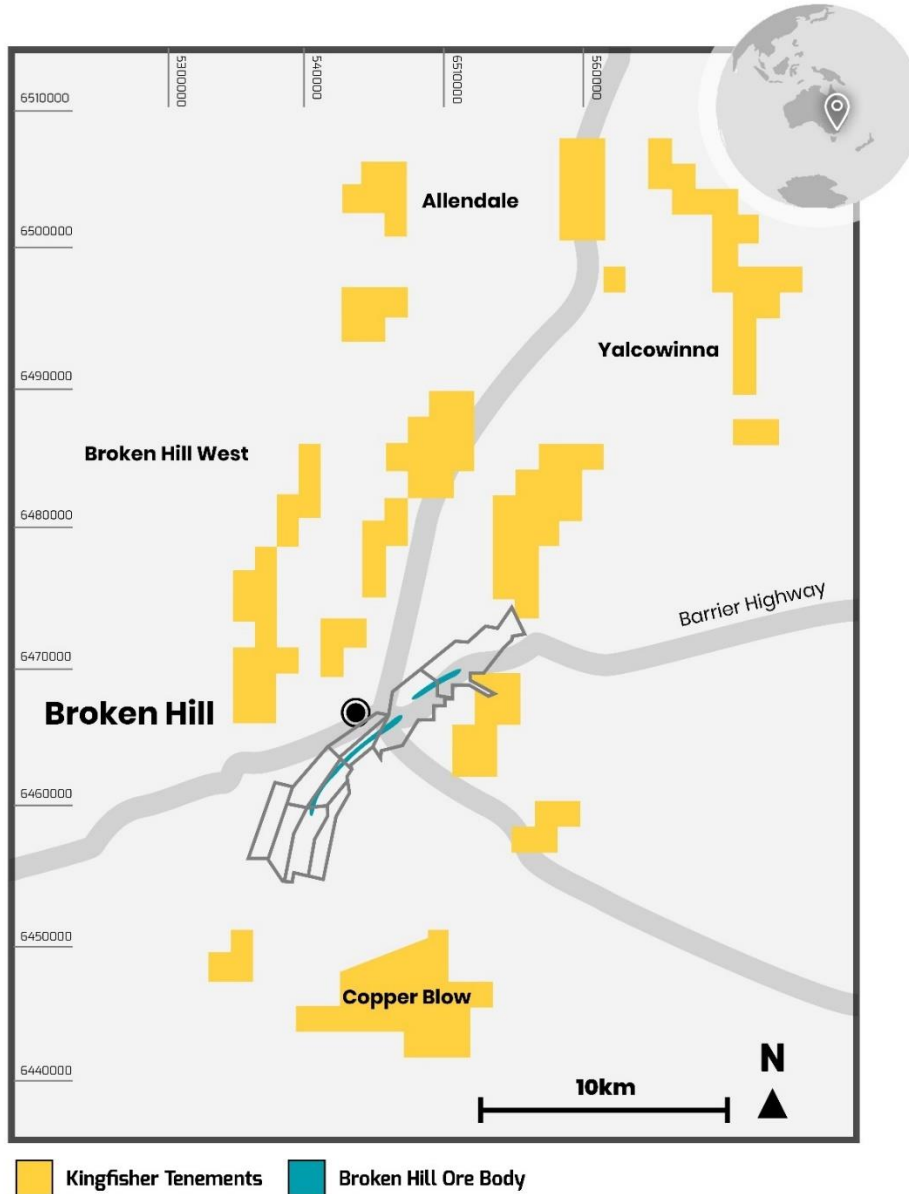
## Gascoyne Projects

During the quarter limited work was undertaken on the Lithium and REE projects given the sentiment associated with the respective markets. The Company remains confident that the Lithium and REE markets will improve in the medium term and the Company will continue to advance these projects and in particular the high grade Mick Well project for which the Company has already defined over 20km of mineralised strike and identified three major carbonatite structure believed to be the main REE host.

## Corporate

The Company closed the quarter with \$1.472M in cash, details are provided in the Appendix 5B report. Together with Kingfisher's shareholding in Black Cat Syndicate Ltd (BC8:ASX), the Company's cash and listed investments currently stand at approximately \$1.627M based on the BC8 closing price on 30 June 2025. Payments reported in Section 2.1(d) of the Appendix 5B for exploration and evaluation during the quarter totalled \$42K. Payments reported in Section 6 of the Appendix 5B were to Directors and include Director fees during the quarter totalled \$0.43K.

Subsequent to quarter the Company announced a capital raising of approximately \$1,854,300 (before costs) through a placement to sophisticated and professional investors and a subsequent non-renounceable entitlement issue to eligible shareholders as outlined above.

**NSW Portfolio Acquisition Projects Overview**
**Broken Hill**


**Figure 1. Broken Hill Projects Location plan**

**Copper Blow copper-gold Project (EL8862 and EL8863) Broken Hill, NSW (75% KFM)**

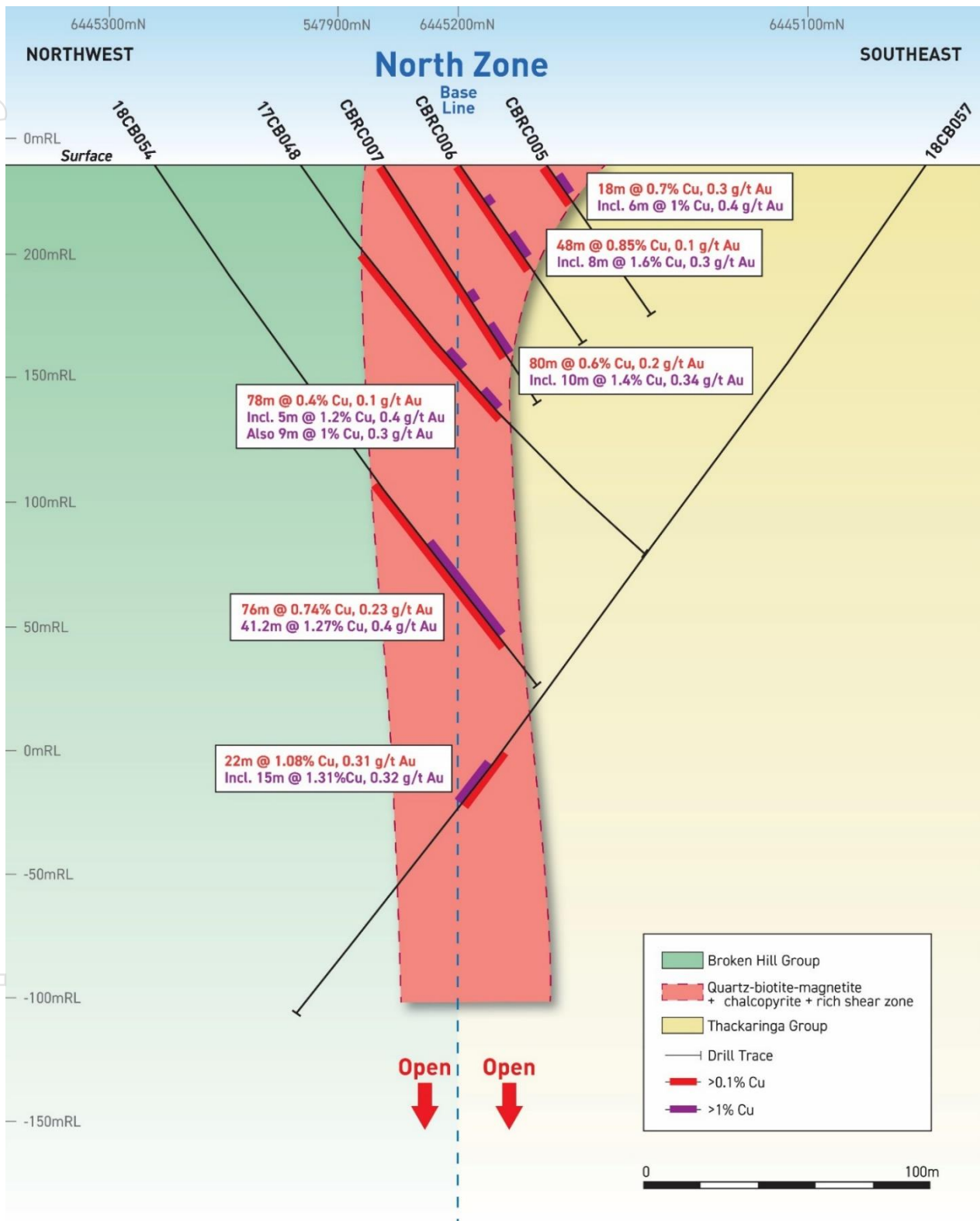
The Copper Blow project is located 20km SE of the city of Broken Hill. Copper Blow is an Iron Oxide Copper Gold (IOCG) prospect which hosts high grade copper and gold mineralisation. The project is held under a Joint Venture agreement with Kingfisher as part of the transaction maintaining a 75% interest and Broken Hill Mines 25%. Austin Metals/Silver City has completed 32 drill holes for over 8,400 metres over four rounds of drilling from August 2017 to September 2018. It includes 4,460m of reverse circulation drilling and 4,034m of core drilling. Drilling shows that copper-gold mineralisation occurs as sulphides within a magnetic ironstone, the Copper Blow Shear zone.

Additional drilling was completed by Acacia Resources Ltd in 1994 and Triako Resources in 2004. Following successful drilling results, Silver City Minerals Ltd completed preliminary metallurgical sighter test work in 2018 which indicated copper recoveries of 96% in a rougher concentrate. No Mineral Resource estimate has been completed on the Copper Blow mineralisation.

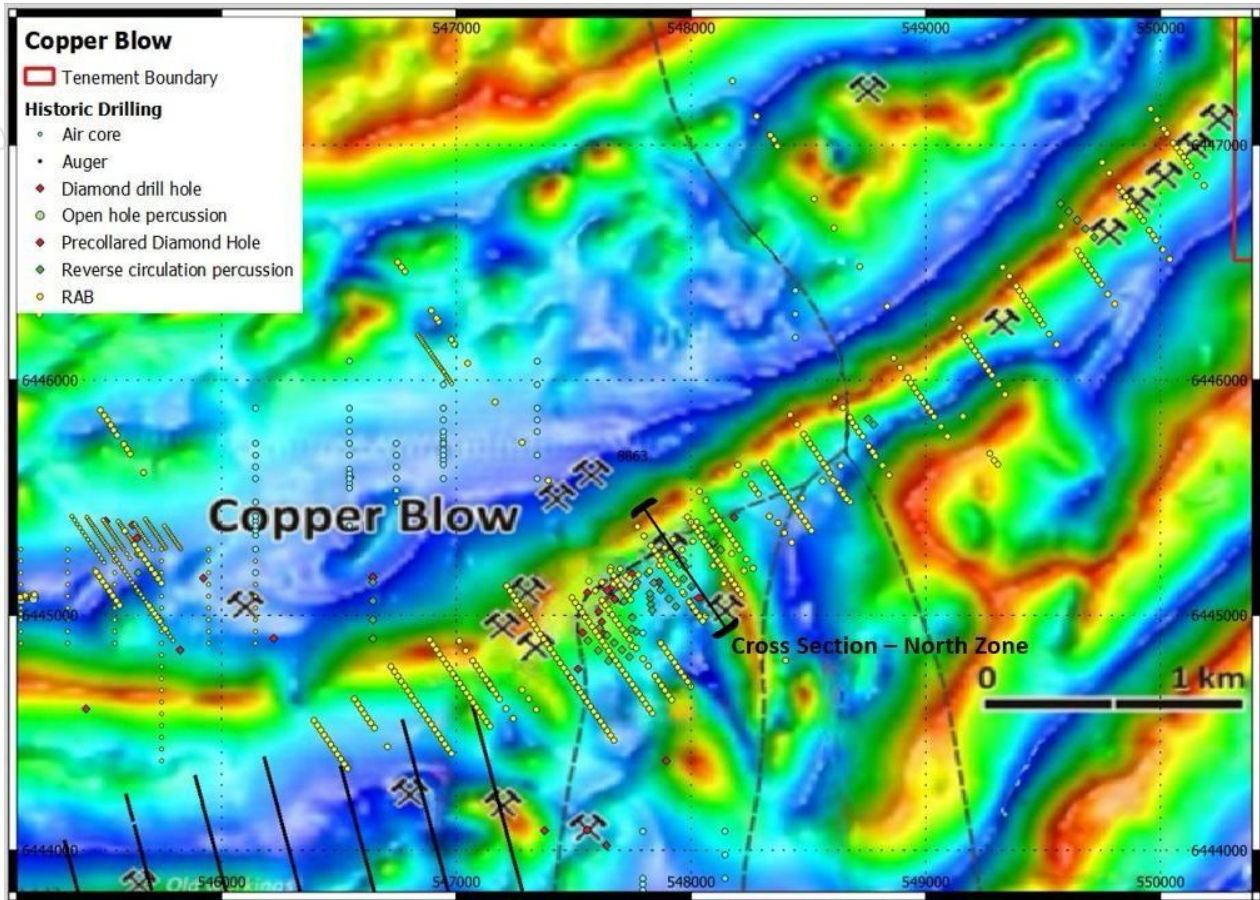
There is over 4.5km of prospective stratigraphy with approximately one kilometre of strike mineralisation effectively tested by Austin and earlier explorers. Mineralisation has been defined over 2 separate zones a North and a South Zone separated by a fault over 600 metres of strike. The Southern zone appears to be characterised by more discrete high grade copper gold zones whilst the north zone is characterised by broader lower grade copper gold grades. Historical shallow RAB drilling between 3 and 12m depth by Rasturn Pty Ltd in 1984 was completed on 300m spaced lines over the 4.5km. A line of deeper RC holes to a maximum depth of 108m was drilled by Triako Resources in 2004 approximately 1.2km North of the historic workings. The drilling especially the RAB is not considered to be drilled to an effective depth to test potential mineralisation given the potential plunge of the mineralisation. Results from historical RC and diamond drilling focussed on the North and South ore zones include:

- **16m @ 2.67% Cu, 0.62 g/t Au and 4.04 g/t Ag from 133m in 84DDHCB06**
- **4m @ 6.13% Cu, 4.23 g/t Au and 12.93 g/t Ag from 188m in 17CB041**
- **4m @ 3.48% Cu, 2.39 g/t Au and 5.9 g/t Ag from 177m in 84DDHCB06**
- **7m @ 3.7% Cu, 1.07 g/t Au and 5.5 g/t Ag from 126m in 17CB045**
- **8.22m @ 1.87% Cu, 0.53 g/t Au and 3.09 g/t Ag from 131.78m in 17CB043**
- **41.2m @ 1.27% Cu, 0.4 g/t Au and 1.53 g/t Ag from 183.8m inc. 7m @ 2.23% Cu and 0.99 g/t Au from 189m in 18CB054**
- **22m @ 1.08% Cu, 0.31 g/t Au and 1.63 g/t Ag from 278m inc. 15m @ 1.31% Cu and 0.32 g/t Au from 285m in 18CB057**

For personal use only

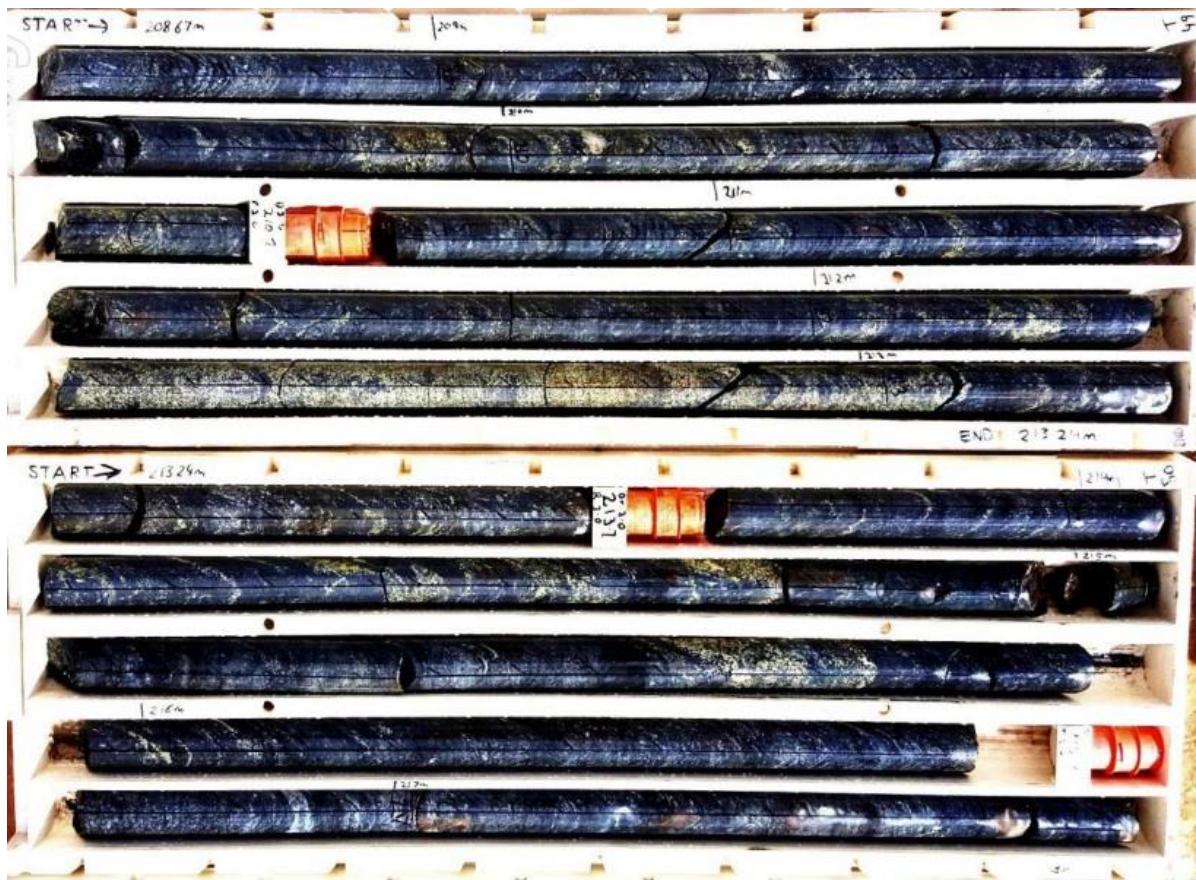


**Figure 2.** Copper Blow Cross Section North Zone



**Figure 3.** Copper Blow magnetics with historic drilling.

Copper Blow is considered to be the largest IOCG prospect in the Broken Hill Block. Past recorded production totals 726 tonnes of copper-rich ore between 1887–1937. It has been classified as a Sisters-type deposit (Barnes 1988), who defines it as epigenetic syn- to late-tectonic strata bound Fe–Cu–Au mineralisation. Barnes 1988 describes the Sisters-type quartz–magnetite horizons as stratigraphically controlled and dominantly developed within the Thackaringa Group rocks. They comprise of quartz–magnetite zones with locally abundant apatite with accessory orthoamphibole, biotite, feldspar, epidote and retrograde chlorite–muscovite. Pyrite (commonly cobaltiferous) and/or pyrrhotite are abundant in many zones whilst chalcopyrite is minor but widespread.



*Hole 18CB054 intersection disseminated chalcopyrite-pyrite with accessory pyrrhotite in magnetite-chlorite quartz shear, 7m @ 1.97% Cu and 0.48 g/t Au from 208m downhole*

Kingfisher sees a near term opportunity to evaluate the remaining untested strike extent of the host stratigraphy of the Copper Blow mineralisation over 3.5kilometres. This will involve review of the existing geophysical dataset and infill and extensional drilling to the existing 600m of strike already defined at Copper Blow with a view to complete an initial JORC compliant Mineral Resource estimate.

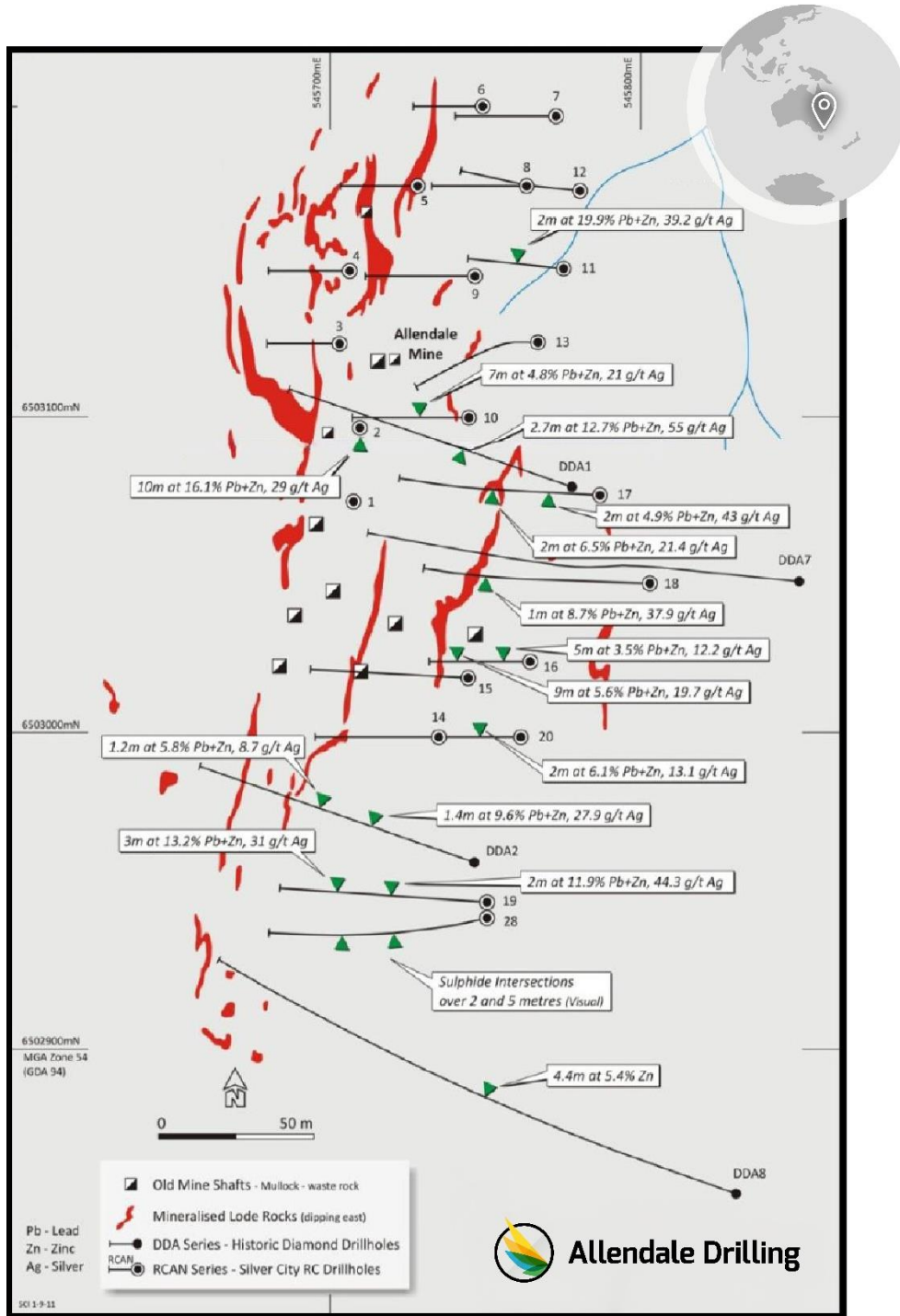
#### **West Broken Hill Lead-Zinc-Silver Prospects (EL 8075 75% KFM, EL 8077 100% KFM, EL 7300 85% KFM and EL 8495 100% KFM)**

Located between 10-40km NNW of Broken Hill the projects are located in and around a number of historic mines associated with the Parnell Formation of the Broken Hill Group with a particular focus on the historic Allendale mine. The lithologies seen at Allendale in mapping and historic drilling include a garnet biotite gneiss, amphibolites and both metamorphosed psammitic and pelitic sediments. Late pegmatites crosscut the sequence as is seen elsewhere in the region. Mineralisation is characterised by base metal sulphides hosted in what was referred historically to as "lode rock" and is made up of bluish granular quartz and a garnet quartzite. Exploration was undertaken from the late 60's and North Broken Hill Ltd carried out a limited diamond drilling program around the old workings in 1969 targeting IP anomalies and a major sulphide body. Best results were in DDHA1 which returned 2.7m @ 12.7% Pb+Zn and 55 g/t Ag from 67.5m. Silver city undertook RC drilling in 2011 with best results including:

- **10m@16.1% Pb+Zn and 29 g/t Ag from 15m, inc. 1m@ 38.3% Pb+Zn and 80.1 g/t Ag from 15m and 2m@ 33.8% Pb+Zn and 43.3 g/t Ag from 18m in RCAN002**
- **2m@ 19.9% Pb+Zn and 39.2 g/t Ag from 47m in RCAN011**
- **2m@ 13.8% Pb+Zn and 51.1 g/t Ag from 117m in RCAN016**
- **3m @ 13.2% Pb+Zn and 31.0g/t from 78m in RCAN019**

Kingfisher sees the opportunity to review the historic drilling at all these prospects and focus on smaller scale high grade opportunities where the silver tenor is higher.

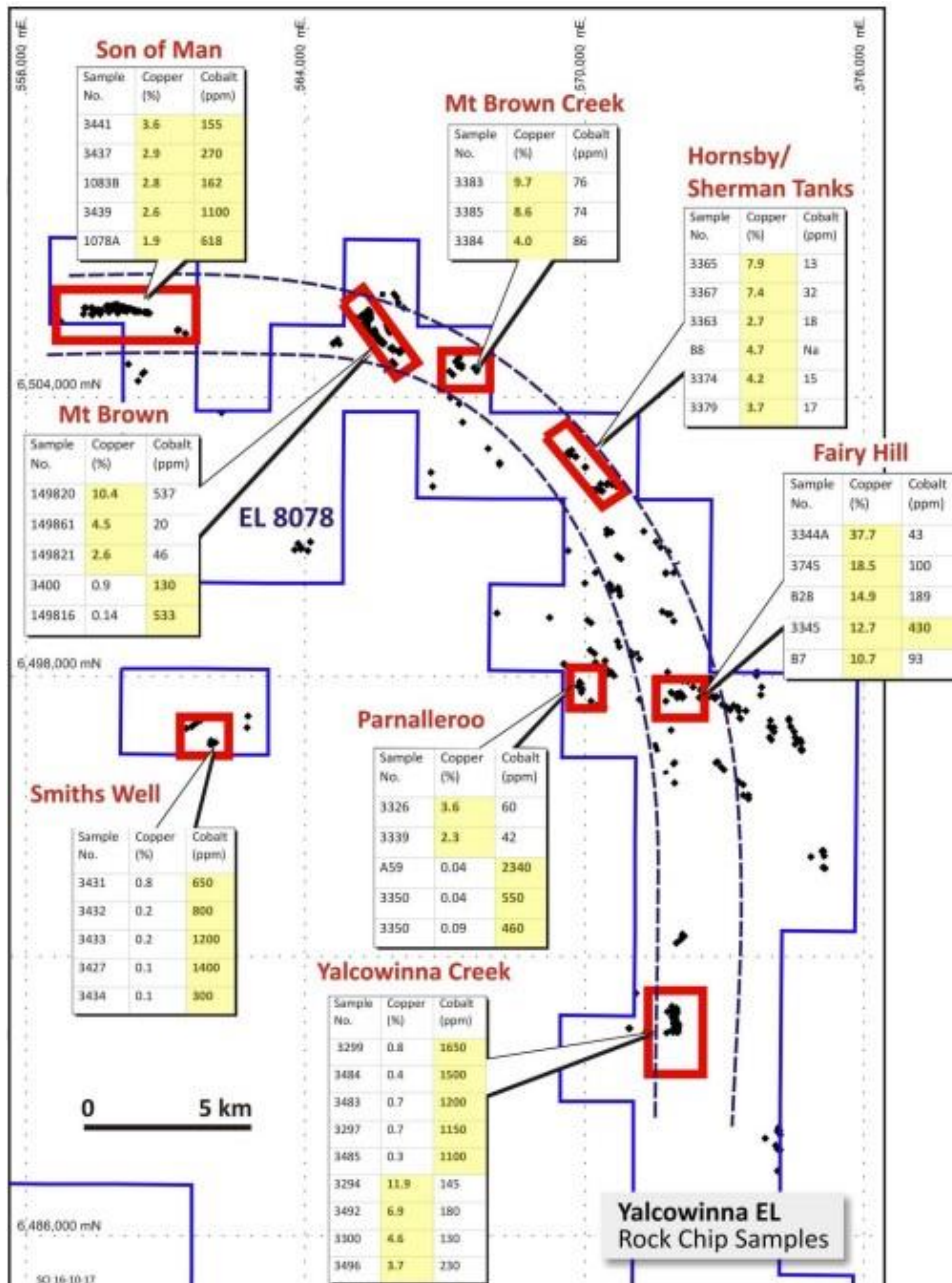
For personal use only



**Figure 4.** Allendale drilling after SCI:ASX announcement 27 September 2011

**Broken Hill- Yalcowinna Copper cobalt prospects (EL8078) (100% KFM)**

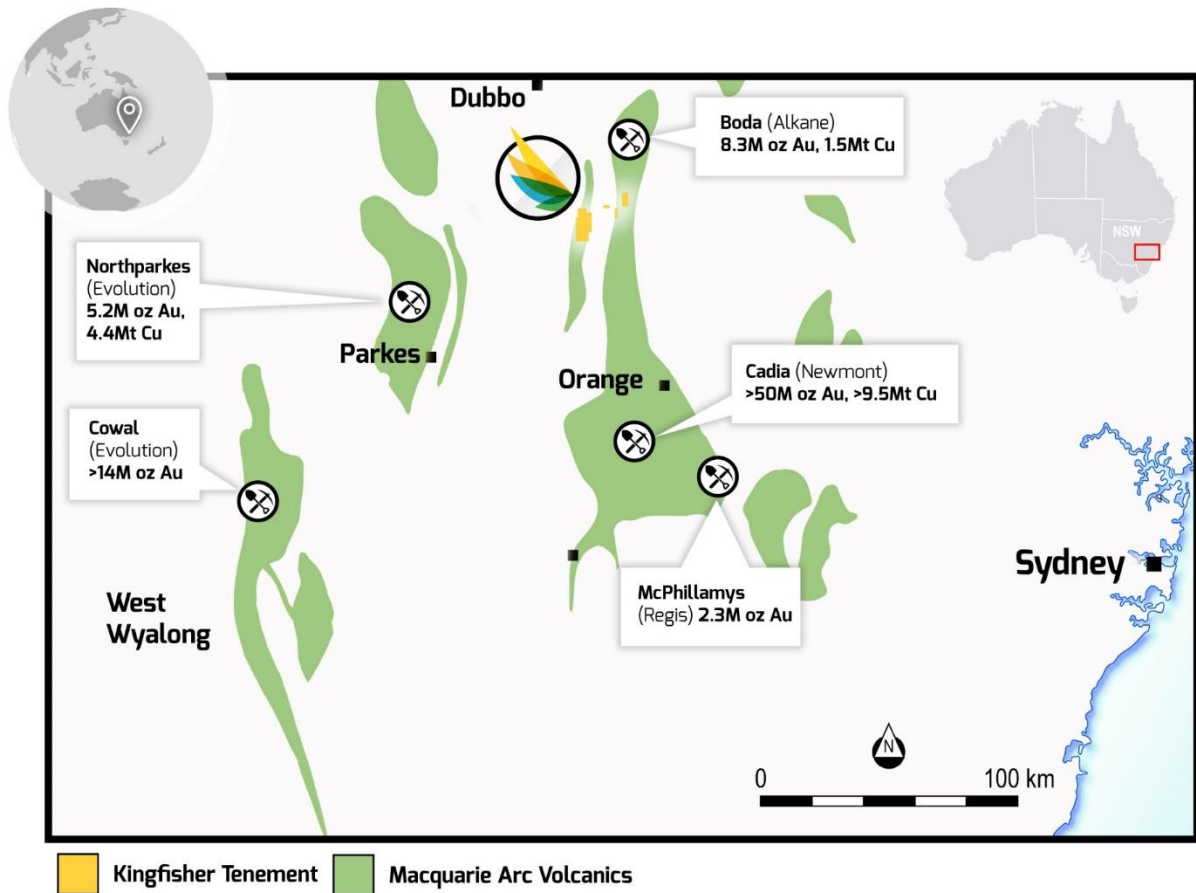
The Yalcowinna tenement package is located 30 kilometres to the northeast from Broken Hill and extends for over 25 kilometres of strike with historic rock chip sampling indicating a belt of copper and copper-cobalt occurrences. The area has old workings at several prospects and been the subject of historic drilling predominantly shallow RAB however limited deeper RC drilling has been undertaken around Mt Brown and Fairy Hill workings and gossan, with broad low grade copper intersected at Fairy Hill. Copper mineralisation was previously identified during field mapping by the NSW Geological Survey and former explorers. Multiple gossans remain untested.



**Figure 5.** Yalcowinna rock chips from SCl:ASX announcement 17 October 2017

**Wellington Copper–Gold Project (EL 8971) Macquarie Arc, NSW, 100% KFM**

Located in the Macquarie Arc within favourable volcanic stratigraphy, the key prospect is the Willunga prospect located 15km away from the Boda/Kaiser porphyry–copper deposits owned by Alkane, which hosts an estimated Indicated and Inferred Mineral Resource containing 8.28 Moz Au and 1.46Mt of Cu\*



**Figure 6.** Location plan Wellington project

(Total metal endowment from Harris et al 2020, Alkane 2024, Regis 2023 and Evolution 2023)

All of these prospects were explored by Placer in the late 60s with Placer defining a 1200m long copper anomaly with peak values up to 2,000 ppm copper hosted in andesite at Willunga. A continuous 50 ppm molybdenum anomaly was also defined over the eastern end of the copper anomaly and had peak values of 80ppm molybdenum. Limited surface workings were identified in mapping by Placer and no records of historic production are cited. A summary from the 1968 Placer exploration report states: "Interest was focussed on the property by copper mineralization – mainly malachite and azurite in old gougings in the andesite. Pyrite, chalco-pyrite, chalcocite, and molybdenite are also present in smaller amounts, in most cases in quartz. A dump, however, contains appreciable molybdenite and chalcopyrite in granitic material". (Placer 1968)

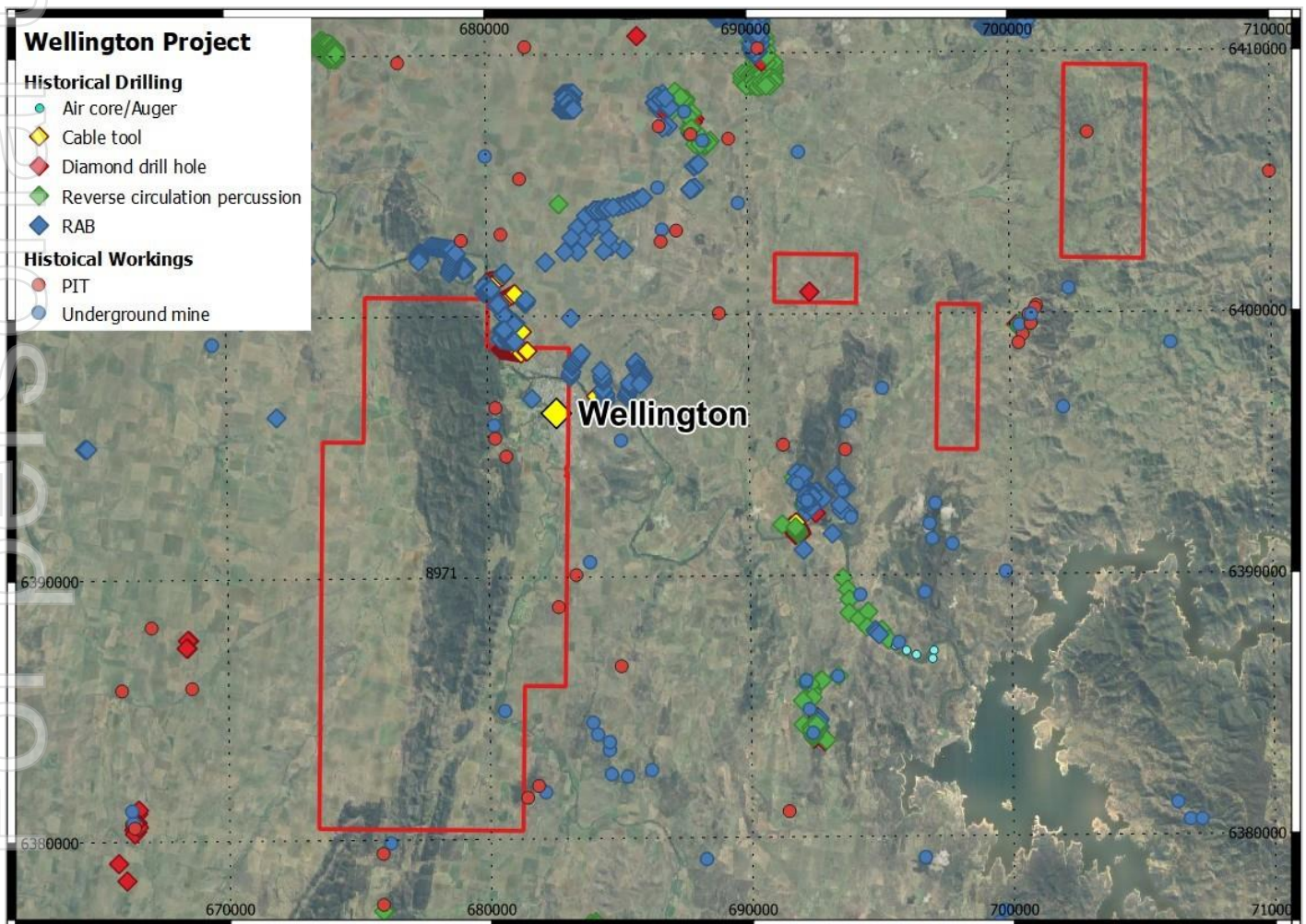
2 diamond drill holes were drilled by Placer in 1967 targeting geochemical anomalies and IP targets.

D.D.H. W1 was drilled –at 40-degree dip to azimuth 040 to approximately 108.5m total depth, the hole intersected andesite with sporadic chalcopyrite and less molybdenite and went into aplite dykes and granite to the end of the hole.

D.D.H. W2 was drilled at -45-degree dip to azimuth 040 to approximately 215m total depth, the hole intersected sheared and foliated andesite with minor chalcopyrite before grading into greywacke and siltstone with more significant sulphides as pyrite and minor chalcopyrite over 7 metres from 193m downhole. Eighteen samples were taken with no gold and very low copper and molybdenum values results returned. A spectrographic scan was undertaken on a 3m interval from 154 metres downhole and returned 238ppm Cu, 2ppm Ag, 8ppm W, 40ppm Te and 45ppm Sb.

It was concluded from this work was that no further exploration was considered warranted at this time. Interestingly Boda was evaluated at the same time and the same conclusion was drawn, whilst more work was undertaken on the Kaiser deposit Placer did not consider it to have the potential to be of a scale that warranted further attention at that time. (Placer 1968).

The broader tenure has been covered by regional scale stream sediment sampling which assayed for base metal suites, minimal precious metal gold and silver assay and limited multi-element trace element geochemistry. Limited RAB, cable and mud rotary drilling was undertaken on the western tenure. Kingfisher considers this project to still represent an exciting early-stage exploration play and proposes to undertake initial ground-based geophysics to identify any potential targets for drill testing at Willunga.



**Figure 7.** NSW MinView plan showing historic drilling

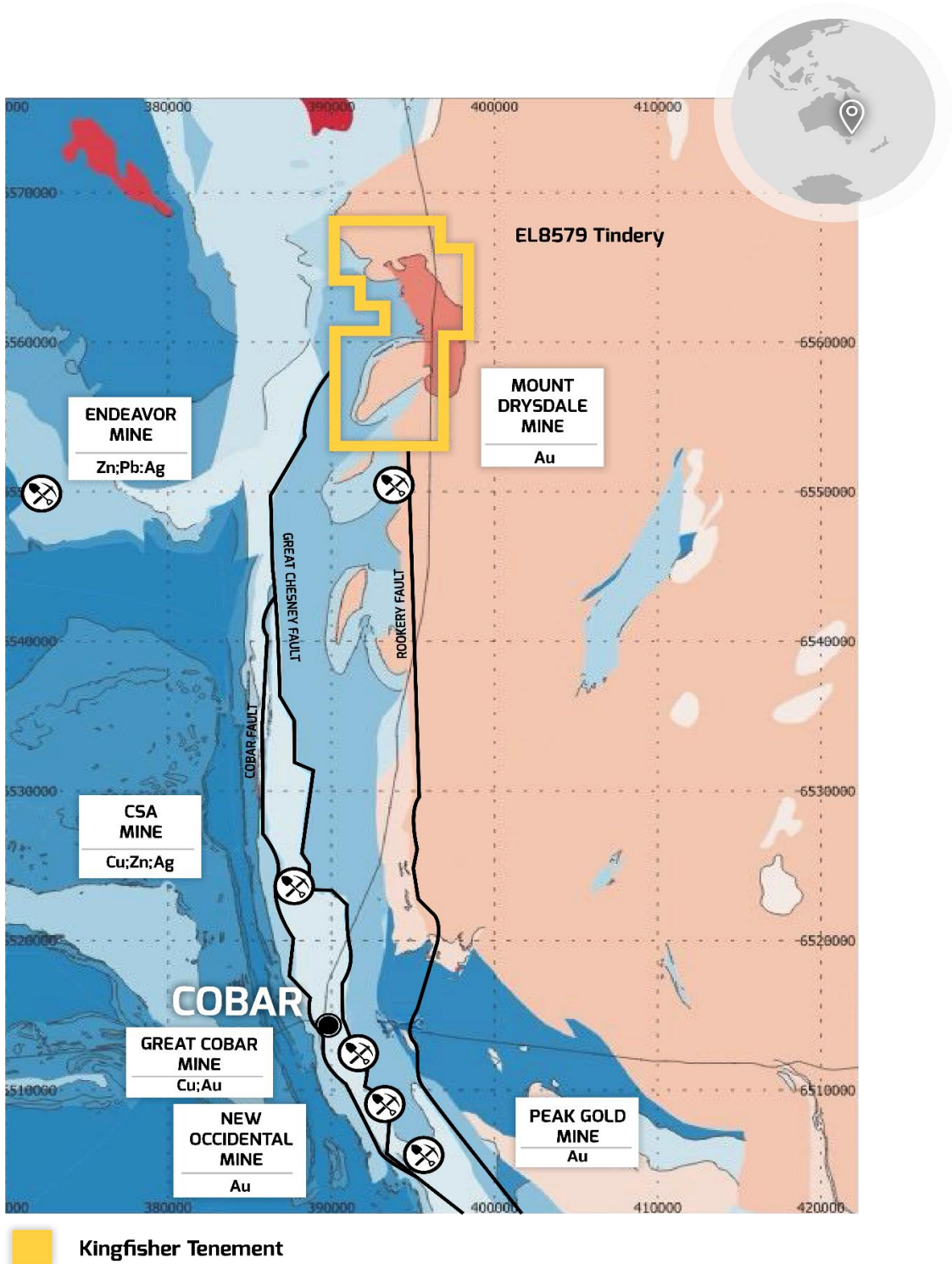
\*Alkane Resources Ltd ASX announcement Annual Resources and Reserves Statement FY24-4 September 2024

**Tindery Gold Project (EL 8579), Cobar, NSW, 100% KFM**

The tenement lies on the eastern margin of the Cobar Basin which is part of a larger Siluro-Devonian rift system. Most of the area is underlain by highly deformed and metamorphosed siltstones, sandstones, conglomerates and cherts of the Girilambone Group. These are intruded by muscovite-biotite granites of the Tinderra Granite.

For personal use only

For personal use only



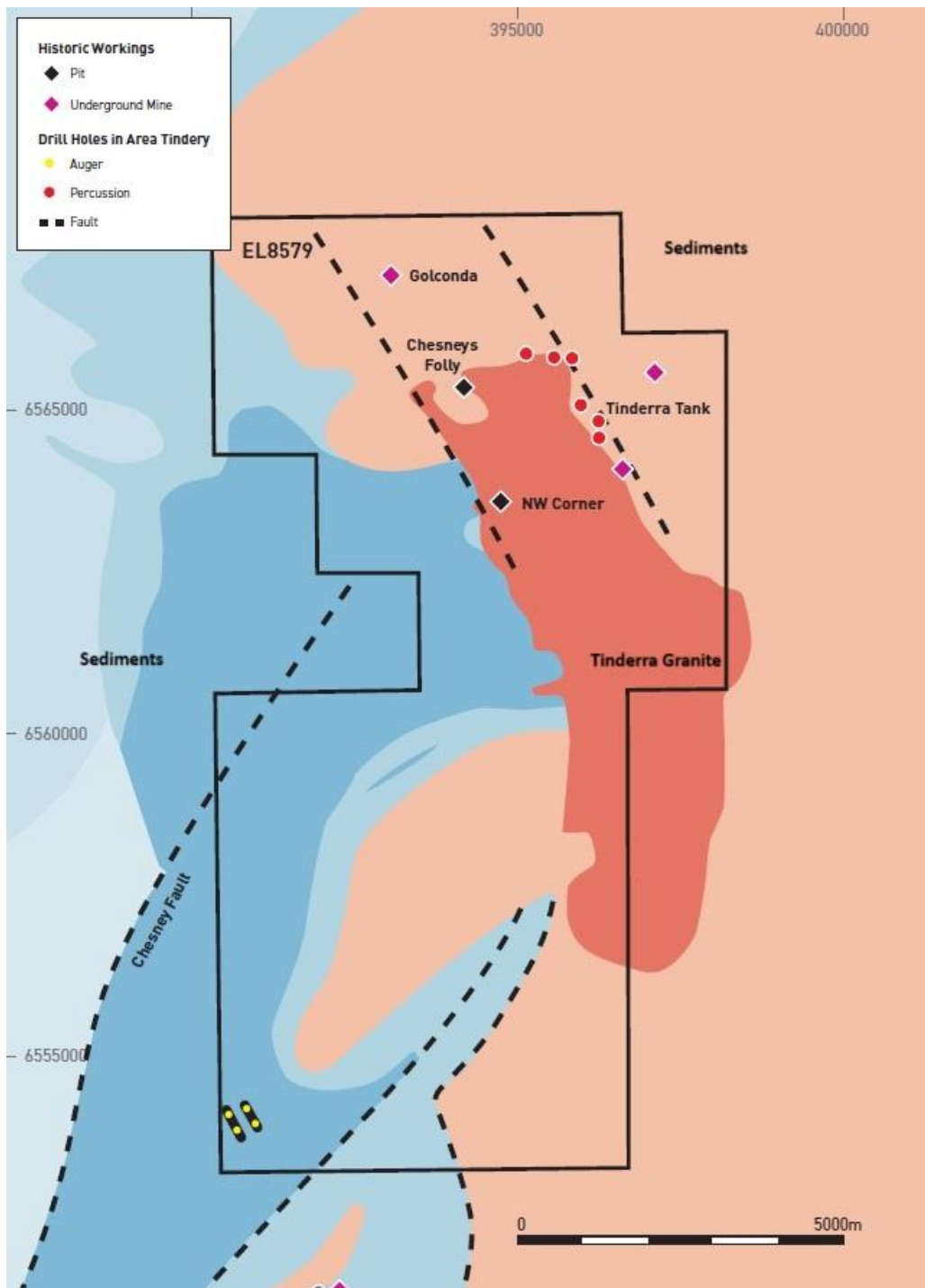
**Figure 8.** Tindery tenement plan with prospects and historic drilling (base plan from NSW MinView).

A number of significant gold occurrences are present south of the tenure on the Chesney Fault which strikes into the southern part of EL8579. There are a number of faults within the tenement which are considered prospective for evaluation for gold mineralisation.

These include the historic Golconda mine, with historic mines department records stating that three shafts (depths 30, 70 and 80ft) were sunk in 1905 on "lines of reef" which appear to parallel the cleavage, and strike at 225 to 235 magnetic. The main line of old workings "lies in a 50m wide zone of discontinuous alteration", this is where a 50m wide up to 300m striking zone of quartz stockwork is present within chlorite altered sediments and has not been drill tested. Samples from historic dumps at Golconda graded as high as 2.5ppm Au.

Limited Drilling in the north-east of the tenement is concentrated over the gold occurrences of Chesneys Folly and Tinderra Tank. The Tinderra Tank prospect was RAB drill tested by Dominion in 1993 with peak gold values of 0.83 ppm. A water bore drilled by CSA was completed in 2018 and sampled by SCI however no significant results were returned. The Golconda mine which does not appear to have been drilled and the Chesney's Folly prospect present opportunities for drill testing following further soil geochemistry and on ground assessment.

For personal use only



**Figure 9.** Tindery tenement plan with prospects and historic drilling (base plan from NSW MinView).

### Next steps

Kingfisher plans to immediately commence landholder and stakeholder engagement in advance of on ground field assessment and follow-up exploration programs. The immediate focus will be on prioritising near-term drill targets across the Projects but with particular focus on the Copper Blow prospect where there is the nearest term potential for the generation of a JORC compliant Mineral Resource Estimate.

For personal use only

## GASCOYNE PROJECTS

Kingfisher's breakthrough Mick Well REE discovery and its Chalby Chalby Lithium Project both occur within the Company's extensive 938km<sup>2</sup> Gascoyne tenement holding which covers a strike length of 54km along the crustal-scale Chalba Shear Zone (Figure 10). The tenure is prospective for carbonatite REE mineralisation similar to Hastings Technology Metals' world-class Yangibana Deposit (see ASX:HAS 11 October 2022) as well as the recent Yin and C3 discoveries of Dreadnought Resources (see ASX:DRE 30 November 2023). The Company's Gascoyne tenure is also prospective for lithium-bearing Thirty Three Suite Pegmatites that host Delta Lithium's Yinnetharra Project (see ASX:DLI 27 December 2023).

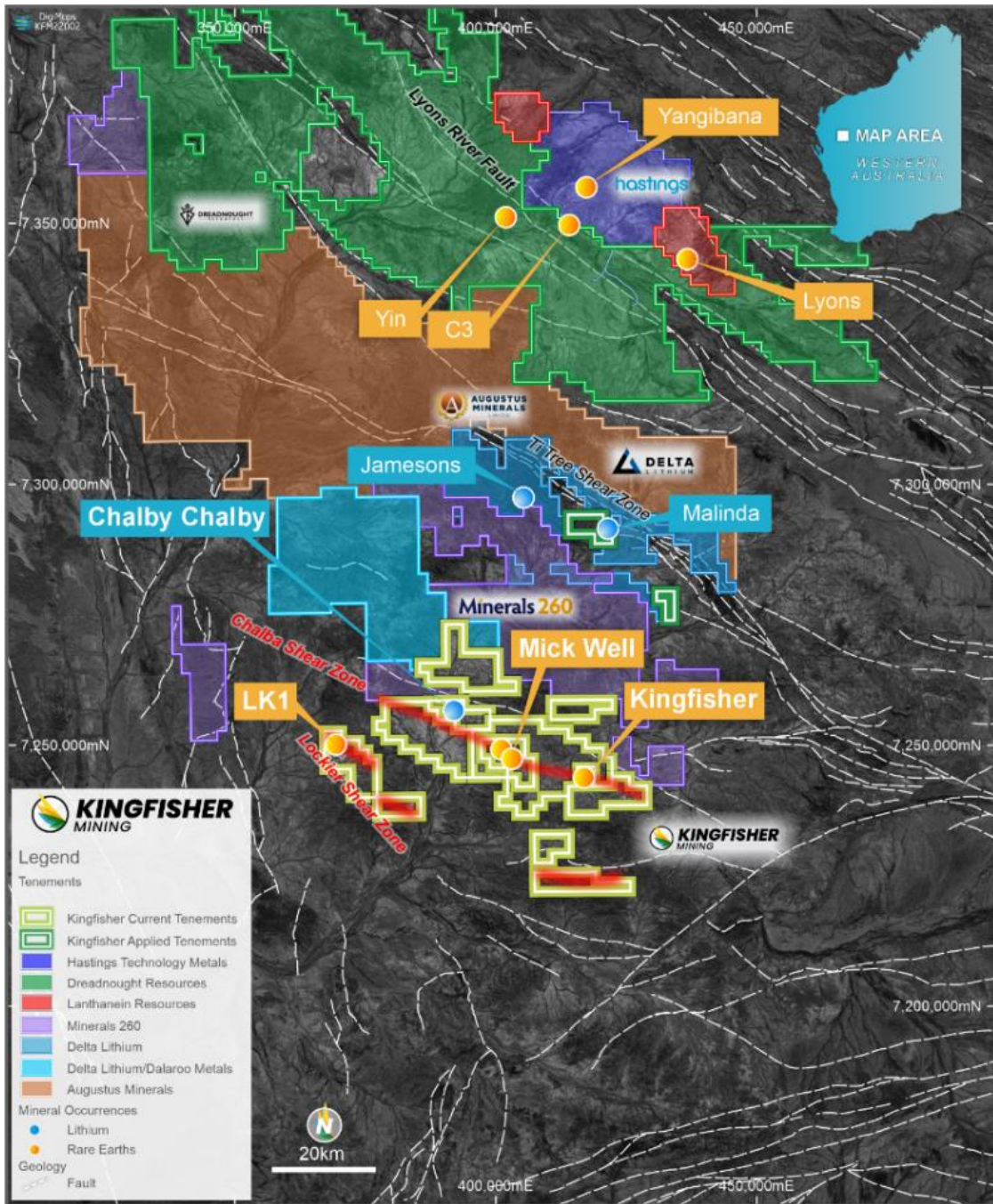
### Mick Well REE Project

Mick Well occurs within a large-scale carbonatite intrusion centre that extends over an area of 10km by 7km. The Company has delineated 20km of strike of high-grade REE mineralisation in dykes and veins which envelop and radiate away from three pipe-like features that have been delineated from geophysical surveys. Each of the large pipes targets is more than 1,000m in diameter and close to surface with the depth to the top of each target being less than 50m below the ground surface. The carbonatite pipe targets are all located in the centre of the large-scale area of outcropping carbonatites and associated fenite alteration. Kingfisher has interpreted the three pipe-like features to be the potential source of the high-grade dyke and vein mineralisation as well as the clay-hosted REEs that also occur in the area (Figure 11).

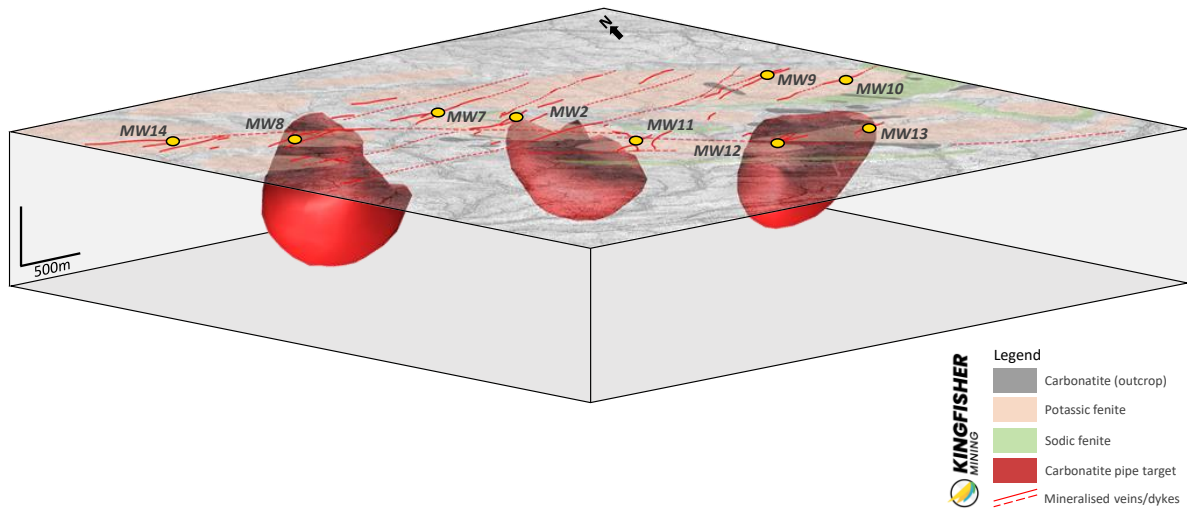
High grade discoveries of REE mineralisation have been made by the Company at MW2, MW7, MW8, MW9, MW10, MW11, MW12, MW13 and MW14. The REE mineralisation dominantly occurs as monazite and is associated with ferrocarnatite intrusions and exceptionally high-grade veins that fill structures around the modelled intrusion centres. Drilling at MW2 has returned the following highly encouraging results:

- **MWRC011:** 5m at 3.45% TREO with 0.65% Nd<sub>2</sub>O<sub>3</sub> + Pr<sub>6</sub>O<sub>11</sub> from 102m, including 3m at 5.21% TREO with 0.98% Nd<sub>2</sub>O<sub>3</sub> + Pr<sub>6</sub>O<sub>11</sub> from 102m.
- **MWRC033:** 3m at 2.52% TREO with 0.41% Nd<sub>2</sub>O<sub>3</sub> + Pr<sub>6</sub>O<sub>11</sub> from 46m.
- **MWRC035:** 4m at 3.24% TREO with 0.54% Nd<sub>2</sub>O<sub>3</sub> + Pr<sub>6</sub>O<sub>11</sub> from 46m.
- **MWRC059:** 4m at 1.90% TREO with 0.34% Nd<sub>2</sub>O<sub>3</sub> + Pr<sub>6</sub>O<sub>11</sub> from 65m, including 3m at 2.42% TREO with 0.43% Nd<sub>2</sub>O<sub>3</sub> + Pr<sub>6</sub>O<sub>11</sub> from 65m.
- **MWRC067:** 5m at 2.63% TREO with 0.54% Nd<sub>2</sub>O<sub>3</sub> + Pr<sub>6</sub>O<sub>11</sub> from 124m, including 3m at 4.11% TREO with 0.85% Nd<sub>2</sub>O<sub>3</sub> + Pr<sub>6</sub>O<sub>11</sub> from 124m
- **MWRC068:** 5m at 1.54% TREO with 0.30% Nd<sub>2</sub>O<sub>3</sub> + Pr<sub>6</sub>O<sub>11</sub> from 75m.

The combination of these geophysical responses to the carbonatite geology provide a very powerful combination of exploration tools for early stage targeting and project generation.



**Figure 10:** Location of the Mick Well and LK1 REE Projects and the Chalby Chalby Lithium Project in the Gascoyne Mineral Field. The location of the Yangibana REE Deposit, Yin REE and C3 Deposits which are located 100km north of Kingfisher's projects as well as the Malinda Lithium Deposit which is located 45km north of Kingfisher's projects are also shown.

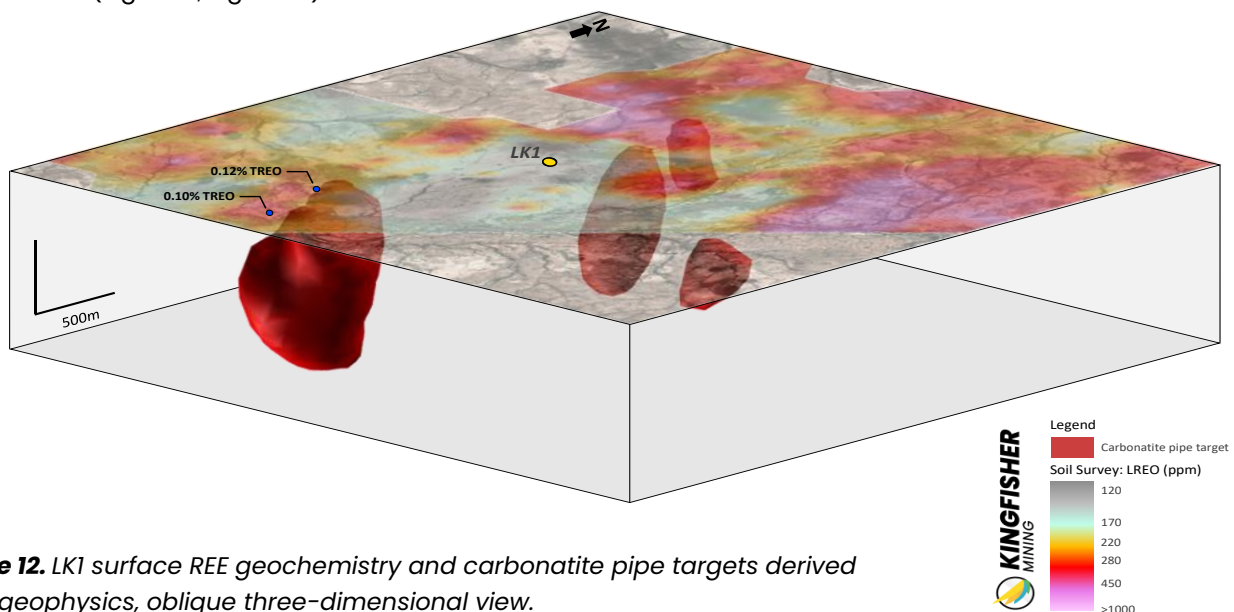


**Figure 11.** Carbonatite pipe targets at Mick Well, oblique three-dimensional view.

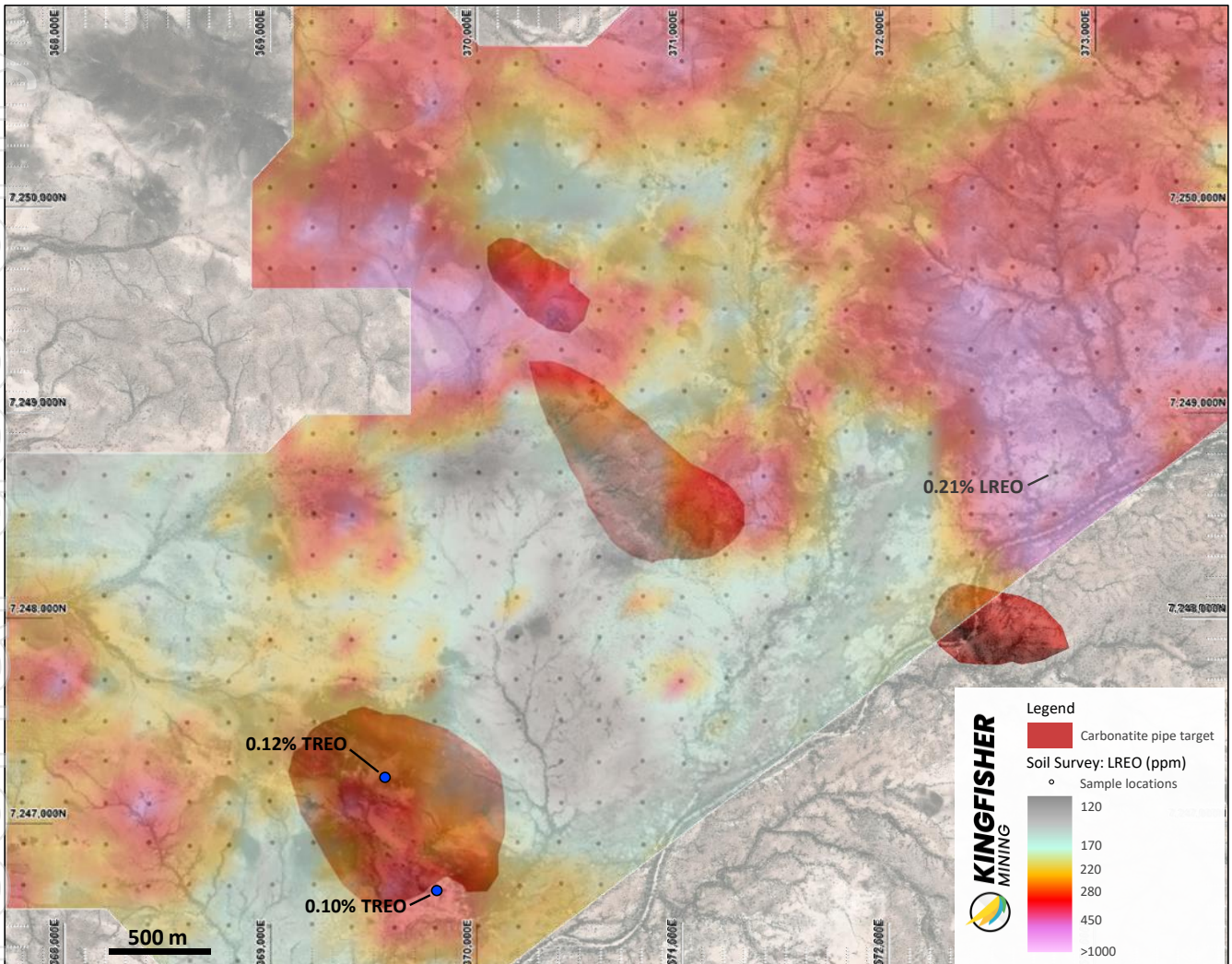
### LK1 REE Prospect

The large-scale LK1 prospect is located 30km west of the Company's breakthrough Mick Well REE discoveries on a separate large shear zone, the Lockier Shear Zone. LK1 is more than 9km long and more than 6.5km wide and was identified by Company due to similarities with the Company's breakthrough Mick Well REE discoveries. The large-scale prospect is comprised of multiple circular features which are defined by the magnetics and thorium responses, with a ring-shaped thorium feature having a diameter of 1.7km (see ASX:KFM 18 January 2023).

Four large carbonatite pipe targets have been identified at the LK1 Prospect from three-dimensional modelling of the gravity and magnetics data. The two larger LK1 pipe targets are both more than 1,000m in diameter, extending from the near surface to depths of more than 1,000m below the ground surface. The combination of magnetic, thorium and potassium responses of the target together with the three-dimensional geophysical models appear similar to the architecture of the carbonatite intrusion model, with potential for carbonatite pipes and the associated vein and dyke mineralisation (Figure 12, Figure 13).



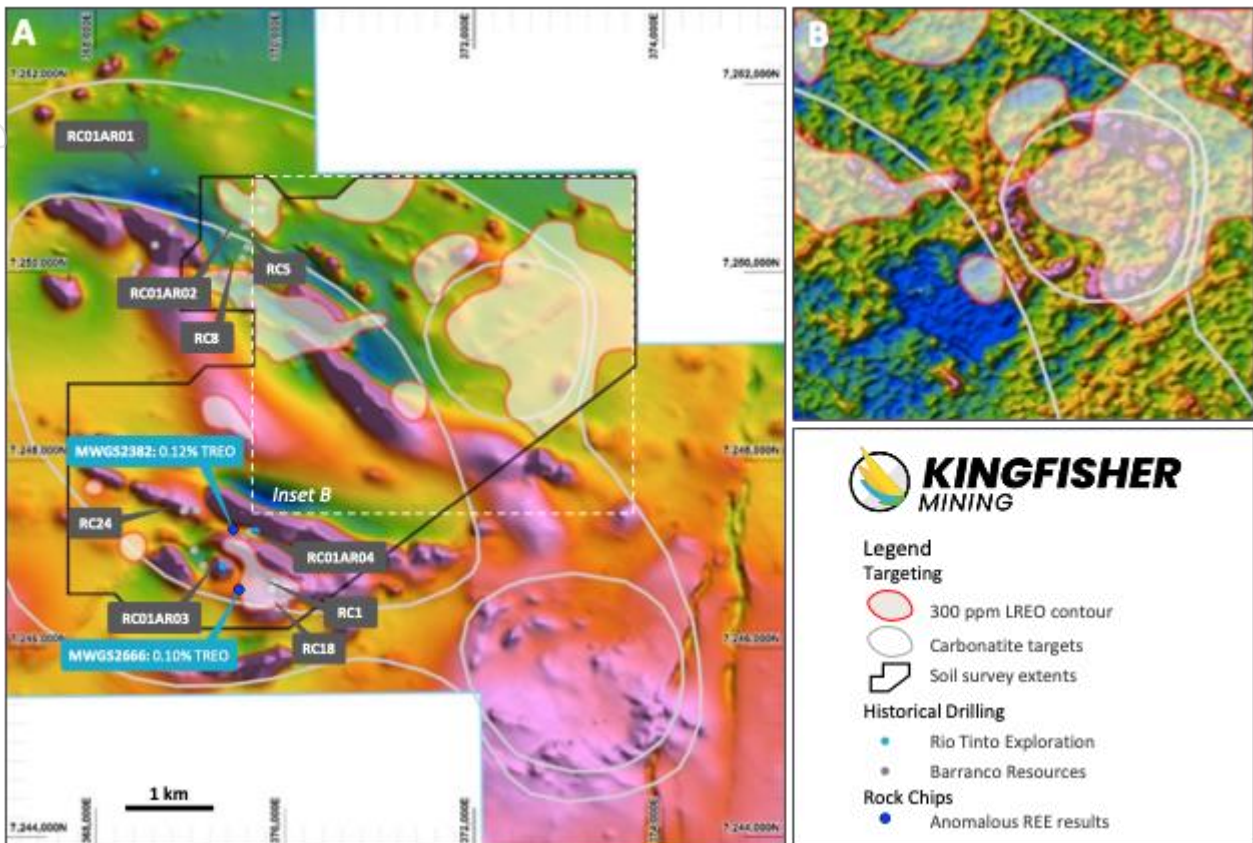
**Figure 12.** LK1 surface REE geochemistry and carbonatite pipe targets derived from geophysics, oblique three-dimensional view.



**Figure 13.** LK1 surface REE geochemistry and carbonatite pipe targets. The REE geochemistry has been calculated from a suite consisting of  $CeO_2$ ,  $La_2O_3$ ,  $Nd_2O_3$  and  $Pr_6O_{11}$ . The carbonatite pipe targets were derived from three-dimensional modelling of the combined magnetics and gravity geophysics data. Anomalous rock chip results associated with the southwestern carbonatite pipe target as well as the peak soil geochemistry value of 0.21% LREO are also shown.

Surface mapping at LK1 has confirmed the presence of ironstones, which have returned anomalous rock chip results of 0.12% and 0.10% TREO. The mapping, geophysics and geochemistry also indicate there are other rock types under cover which are yet to be fully identified.

Several areas with highly anomalous REEs, including a large area with a diameter which extends for more than 2km have also been identified from a soil geochemistry survey completed by the Company. The REE soil anomalies are based on an LREO suite consisting of  $CeO_2$ ,  $La_2O_3$ ,  $Nd_2O_3$  and  $Pr_6O_{11}$ . The high magnitude surface geochemistry results which include a peak value of 0.21% LREO are spatially associated with the carbonatite pipe targets (Figure 14). The broad soil anomaly in the northeast of the target area is also coincident with a circular radiometric feature, a highly significant occurrence and one of the key features recognised during the early-stage target identification at LK1.



**Figure 14.** Total magnetic intensity (A) and thorium responses coincident with anomalous REE soil geochemistry (B). Anomalous rock chips (blue boxes) and historical drill hole locations (grey boxes) described in Table 1 are also shown.

**Table 1:** Previous drilling results from the LK1 target area

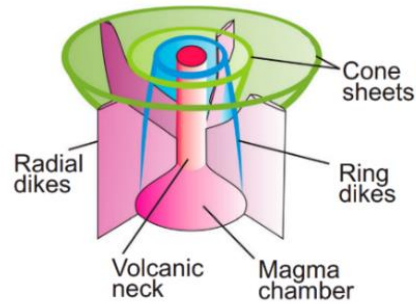
Rio Tinto Drill Hole	Pathfinder elements: highest from 2m samples <sup>1</sup>
<b>ARC01AR01</b>	340 ppm Ce, 195 ppm La, 1100 ppm Ba and 1150 ppm P
<b>ARC01AR02</b>	280 ppm Ce, 165 ppm La, 125 ppm Y, 2600 ppm Ba and 3100 ppm P
<b>ARC01AR03</b>	8900 ppm P
<b>ARC01AR04</b>	1250 ppm Ba and 1400 ppm P
Barranco Drill Hole	Geology and elevated metals <sup>2</sup>
<b>RC1</b>	Ironstone with 7m at 0.25% Zn from 20m
<b>RC5</b>	Ironstone with 25m at 0.29% Zn from surface
<b>RC8</b>	Ironstone with 5m at 0.17% Zn from 20m
<b>RC18</b>	Ironstone with 30m at 0.13% Zn from 10m
<b>RC24</b>	Ironstone with 22m at 0.29% Zn from 1m

<sup>1</sup> Pathfinder elements in the reporting range are associated with REE mineralisation at MW2.

<sup>2</sup> Zinc is associated with the REE mineralisation at MW2. Drill holes not analysed for REEs.

### The Carbonatite Exploration Model

The carbonatite intrusion model has a central carbonatite pipe which is comprised of multiple phases of carbonatite intrusion that is surrounded by ring dykes which form around and radial dykes which radiate out from the central intrusion (Figure 15). The carbonatite exploration model envisages alteration of the host country rock into which the carbonatites intrude, with development of sodic (Na) and potassic (K) fenites around the intrusions which often hosts the REE mineralisation (Figure 16).

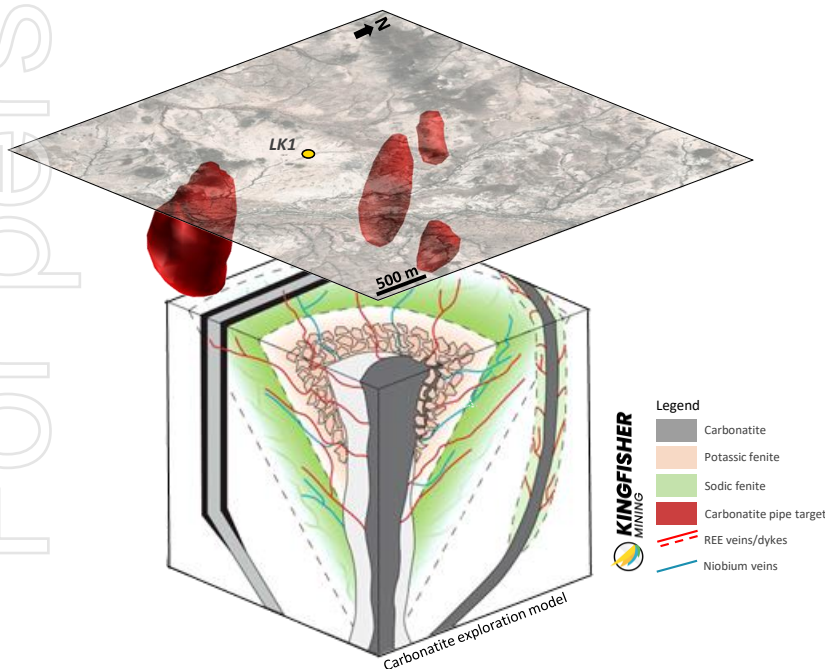


**Figure 15.** 3D schematic of a carbonatite intrusion\*

Each part of the carbonatite system has characteristics which can be detected by modern exploration techniques, for example:

- ① Thorium associated with the REE mineralisation is apparent in the radiometrics.
- ② Potassium fenites, the alteration which forms around carbonatites intrusions, is also apparent in the radiometrics.
- ③ Ferrocarbonatites have high iron content and can appear as magnetic highs in the geophysics.
- ④ Carbonatites typically have high density and can be distinguished from the country rocks by gravity surveys.
- ⑤ ASTER (Advanced Spaceborne Thermal Emission and Reflection Radiometer) remote sensing can detect various minerals and elements, including carbonates, ferrous and ferric iron as well as alumina and magnesium and can assist with of carbonatites and associated alteration.

The combination of these geophysical responses to the carbonatite geology provide a very powerful combination of exploration tools for early stage targeting and project generation.

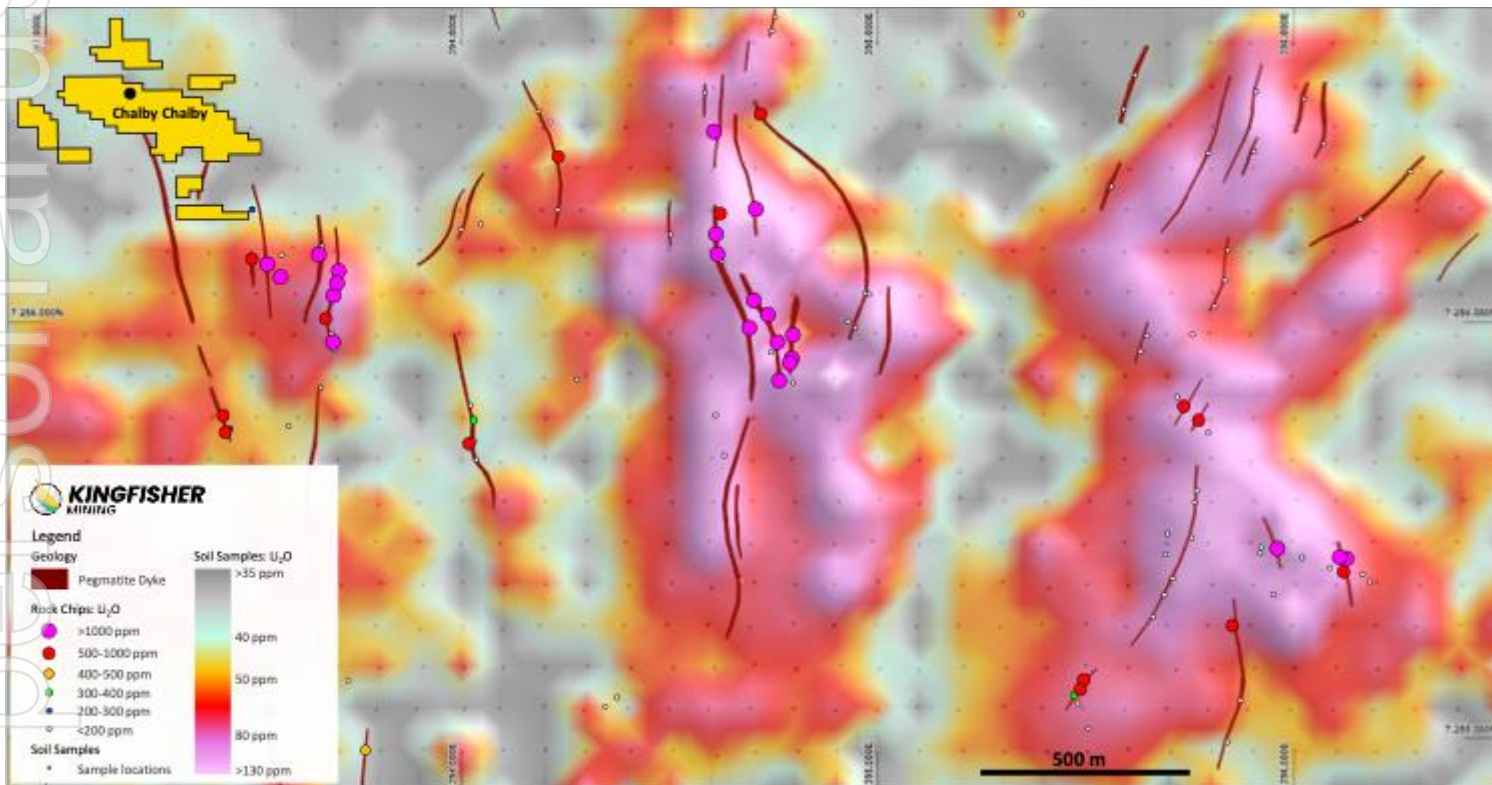


**Figure 16.** LK1 carbonatite pipe targets and the carbonatite associated rare earth element mineralisation model\*. The model shows carbonatite intrusions and dykes, areas of potassic fenitisation as well as the late stage REE-bearing dykes and veins.

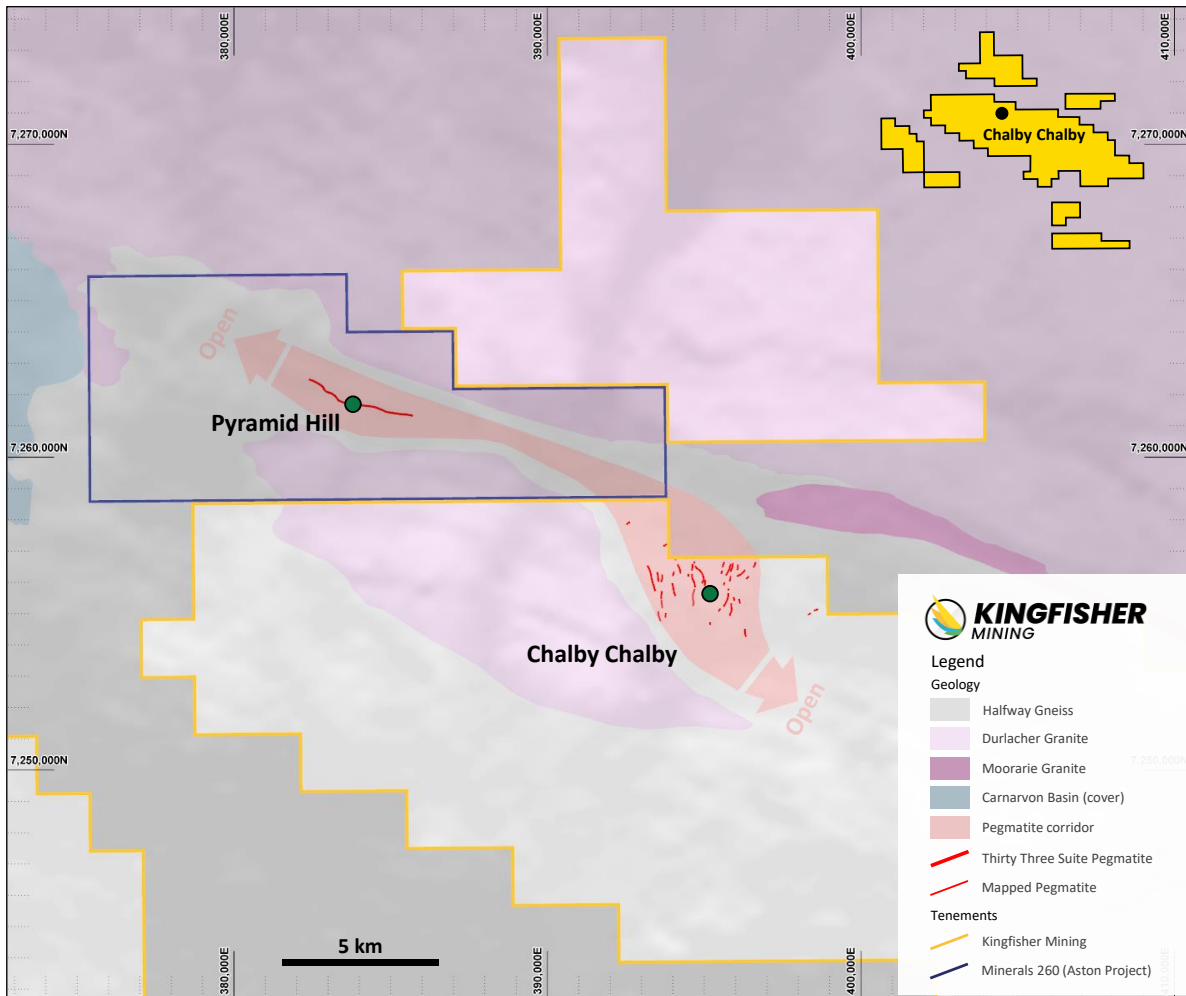
### Chalby Chalby Lithium Prospect

The Chalby Chalby Lithium Prospect is in the north of Kingfisher's extensive Gascoyne tenement holding Mapping and sampling for lithium at Chalby Chalby has delineated multiple stacked pegmatites with a cumulative strike length of over 13km and with rock chip results up to 0.61% Li<sub>2</sub>O (see ASX:KFM 11 September 2023). The pegmatites occur within broad areas of lithium soil anomalism extending up to 1,600m in length and 800m in width. The lithium soil anomalies are associated with, and extend beyond mapped pegmatites, highlighting the potential for discovery of additional lithium-bearing pegmatites (Figure 17). (see ASX:KFM 26 October 2023).

Exploration by Delta Lithium Limited has highlighted the potential of the Gascoyne Thirty Three Suite Pegmatites to host potentially economic lithium mineralisation. Significant spodumene-bearing mineralisation has been reported from Delta Lithium's Yinnetharra Project, which is located 40km northeast of Chalby Chalby. Minerals 260 Limited has also defined a 5km long continuous lithium trend at Pyramid Hill (see ASX:MI6 4 September 2023), which is immediately along strike from Chalby Chalby. The mapping of pegmatites highlights a pegmatite target zone which extends more than 22km around a large granite intrusion of the Durlacher Suite (Figure 18).



**Figure 17:** Chalby Chalby soil geochemistry and rock chip results (see ASX:KFM 11 September 2023 and 7 August 2023).



**Figure 18:** Simplified geology of Kingfisher's Gascoyne projects showing the location of the Company's Chalby Chalby Lithium Prospect and Thirty Three Suite Pegmatite at Minerals 260's Pyramid Hill (Aston Project).

This announcement has been authorised by the Board of Directors of the Company.

**Ends**

**For further information, please contact:**

**Kingfisher Mining Limited**

Scott Huffadine Non-Executive Chairman Ph: +61 (08) 9481 0389

E: [info@kingfishermining.com.au](mailto:info@kingfishermining.com.au)

**About Kingfisher Mining Limited**

Kingfisher Mining Limited (ASX:KFM) is a mineral exploration company committed to increasing value for shareholders through the acquisition, exploration and development of mineral resource projects throughout Australia. The Company's NSW tenure covers approximately 700km<sup>2</sup> with a portfolio of early stage and advanced Copper-Gold and Silver-Lead-Zinc projects, over 3 proven mining districts. The Western Australian tenements cover 938km<sup>2</sup> in the underexplored Gascoyne Mineral Field.

The Company has made a number of breakthrough high grade rare earth elements discoveries in the Gascoyne region where it holds a target strike lengths of more than 54km along the Chalba mineralised corridor and more than 30km along the Lockier mineralised corridor.

To learn more please visit: [www.kingfishermining.com.au](http://www.kingfishermining.com.au)

### Information Sources

The information contained in this announcement related to the Company's past exploration results is extracted from, or was set out in, the following ASX announcements which are referred to in this Quarterly Activities Report:

- The report released 25 July 2025 'Strategic Acquisition of Precious and Base Metals Portfolio'
- The report released 24 April 2025 'Quarterly Activities/Appendix 5B Cash Flow Report'
- The report released 28 January 2025 'Quarterly Activities/Appendix 5B Cash Flow Report'
- The report released 12 October 2024 'Assays Confirm REE and Base Metal Mineralisation, Tranche one of co-funded drilling refund received'.
- The report released 10 October 2024 'High Grade Base Metal Surface Sampling Results at Ring Well Prospect'.
- The report released 02 October 2024 'Co-funded drilling reveals REE mineralisation and extensive carbonatite related alteration zones'.
- The report released 29 July 2024 'Quarterly Activities/Appendix 5B Cash Flow Report'
- The report released 3 July 2024 'Preparation for Drilling MW Carbonatites & Base Metal Review'.
- The report released 6 February 2024 'Completion of Boolaloo Project Sale'.
- ASX Announcement 'Yinnetharra Lithium Project Maiden Mineral Resource Estimate'. Delta Lithium Limited (ASX:DLI), 27 December 2023.
- The report released 20 December 2023 'Mick Well Exceeds 20km of REE Mineralisation'.
- The report released 7 December 2023 'LK1: Another Compelling Carbonatite'.
- ASX Announcement 'Large, High Confidence Yin Ironstone Resource – Mangaroon (100%)'. Dreadnought Resources Limited (ASX:DRE), 30 November 2023.
- The report released 23 November 2023 'High Grade Discoveries Further Expand REE Carbonatites at Mick Well'.
- The report released 14 November 2023 'Significant Additional Carbonatites and REE Mineralisation Identified at Mick Well'.
- The report released 26 October 2023 'Broad Lithium Anomalies Identified from Chalby Chalby Soil Geochemistry Survey'.
- The report released 23 October 2023 'Gravity Survey Confirms Carbonatite Pipe Targets at Mick Well'.
- The report released 3 October 2023 'Further High Grade REE Mineralisation Discovered at Mick Well'.
- The report released 11 September 2023 'Multiple Stacked Lithium-Bearing Pegmatites Mapped at Chalby Chalby'.
- ASX Announcement 'Minerals 260 to accelerate exploration at Aston Project after defining new lithium trend'. Minerals 260 Limited (ASX:MI6), 4 September 2023.
- The report released 7 August 2023 'Lithium-Bearing Pegmatites Confirmed at Highly Prospective Gascoyne Tenure'.
- The report released 10 July 2023 'Carbonatite Intrusions Confirmed at Large-Scale Chalba Targets'
- The report released 3 April 2023 'Significant Exploration Program Targets Large-Scale Carbonatites'.
- The report released 27 February 2023 'Latest MW2 Surface Sample Extend Mineralised Zone'.
- The report released 23 February 2023 'Exciting Carbonatite Potential at Arthur River'.
- The report released 7 February 2023 'High Grade Drilling Results Confirm New MW2 REE Discovery'.
- The report released 23 January 2023 'MW2 and MW7 Continue to Expand on Latest Surface Sample Results'.
- The report released 18 January 2023 'Large-Scale Carbonatite REE Targets Identified at Arthur River'.
- The report released 10 January 2023 'Exciting New Carbonatite REE Targets Along 54km Corridor'.
- The report released 29 November 2022 'Assays from MW7 Confirm Another High Grade REE Discovery'.

- The report released 24 October 2022 'New REE Discoveries along Kingfisher's 54km Target Corridor – MW7 and MW8'.
- ASX Announcement 'Drilling along 8km long Bald Hill – Fraser's trend Increases Indicated Mineral Resources by 50%'. Hastings Technology Metals Limited (ASX:HAS), 11 October 2022.
- The report released 4 October 2022 'Further Exceptional REE Results Extends MW2 Strike Length to 3km'.
- The report released 30 August 2022 '40% REE Returned from Mick Well'.
- The report released 27 July 2022 'Broad Zones of Anomalous REEs Discovered in Mick Well Clays'
- The report released 5 July 2022 'Latest Drilling Returns High Grade REEs with 5m at 3.45% TREO, including 3m at 5.21% TREO'.
- The report released 24 March 2022 'High Grade Rare Earths Returned from Discovery Drill Hole: 4m at 1.84% TREO, including 1m at 3.87% TREO'.
- The report released 10 January 2022 'Significant Rare Earths Discovery: 12m at 1.12% TREO'.
- The report released 21 December 2021 'Kingfisher Confirms Rare Earths Potential at Gascoyne Projects'.

### Technical Exploration Papers

+ Simandl, G.J. and Paradis, S. 2018. Carbonatites: related ore deposits, resources, footprint, and exploration methods, Applied Earth Science, 127:4, 123-152

\* Elliott, H.A.L., Wall, F., Chakhmouradian, A.R., P.R.Siegfried, Dahlgrend, S., Weatherley, S., Finch, A.A., Marks, M.A.W., Dowman, E. and Deady, F. 2018. Fenites associated with carbonatite complexes: A review. Ore Geology Reviews, Volume 93, February 2018, Pages 38-59.

### Total Rare Earth Oxide Calculation

Total Rare Earths Oxides (TREO) is the sum of the oxides of the light rare earth elements lanthanum (La), cerium (Ce), praseodymium (Pr), neodymium (Nd), and samarium (Sm) and the heavy rare earth elements europium (Eu), gadolinium (Gd), terbium (Tb), dysprosium (Dy), holmium (Ho), erbium (Er), thulium (Tm), ytterbium (Yb), lutetium (Lu), and yttrium (Y).

### Forward-Looking Statements

This announcement may contain forward-looking statements which involve a number of risks and uncertainties. These forward-looking statements are expressed in good faith and believed to have a reasonable basis. These statements reflect current expectations, intentions or strategies regarding the future and assumptions based on currently available information. Should one or more of the risks or uncertainties materialise, or should underlying assumptions prove incorrect, actual results may vary from the expectations, intentions and strategies described in this announcement. No obligation is assumed to update forward looking statements if these beliefs, opinions, and estimates should change or to reflect other future developments.

### Competent Persons Statements

The information in this report that relates to exploration results, is based on and fairly represents information reviewed and compiled by Mr Scott Huffadine BSc (Hons), MAIG, Non-Executive Chairman and an employee of Kingfisher Mining Limited, who is a Member of the Australian Institute of Geoscientists. Mr Huffadine has sufficient experience, which is relevant to the exploration activities, style of mineralisation and types of deposits under consideration, and to the activity which has been undertaken, to qualify as a Competent Person as defined in the 2012 Edition of the "Australasian Code for Reporting of Exploration Results, Mineral Resources and Ore Reserves". Mr Huffadine is a Non-Executive Director of Kingfisher Mining Limited and consents to the inclusion in this announcement of the matters based on their information in the form and context in which it appears.

### NSW Portfolio Acquisition Projects Overview

The information is extracted from the report entitled 'Strategic Acquisition of Precious and Base Metals Portfolio' created on 25 July 2025 and is available to view on Kingfisher Mining's website ([www.kingfishermining.com.au](http://www.kingfishermining.com.au)) and the ASX ([www.asx.com.au](http://www.asx.com.au)). The Company confirms that it is not aware of any new information or data that materially affects the information included in the original market announcement.

### Gascoyne Projects Overview

The information is extracted from the following reports entitled 'Latest Drilling Returns High Grade REEs with 5m at 3.45% TREO, including 3m at 5.21% TREO' created on 5 July 2022; 'High Grade Drilling Results Confirm New MW2 REE Discovery' created on 7 February 2023; 'Exciting Carbonatite Potential at Arthur River' created on 23 February 2023; 'Lithium-Bearing Pegmatites Confirmed at Highly Prospective Gascoyne Tenure' created on 7 August 2023 and 'Broad Lithium Anomalies Identified from Chalby Chalby Soil Geochemistry Survey' created on 26 October 2023 and are available to view on Kingfisher Mining's website ([www.kingfishermining.com.au](http://www.kingfishermining.com.au)) and the ASX ([www.asx.com.au](http://www.asx.com.au)). The Company confirms that it is not aware of any new information or data that materially affects the information included in the original market announcement.

### Tenements held at the end of the quarter

Project	Tenement	Registered Holder	Status	Area (Bl)	Expiry Date	Interest Held @ 31-Mar-25	Interest Held @ 30-Jun-25
Kingfisher	E09/2242	Kingfisher Mining Ltd	Granted	4	1 February 2028	100%	100%
	E09/2349	Kingfisher Mining Ltd	Granted	24	21 October 2025	100%	100%
	E09/2481	Kingfisher Mining Ltd	Granted	79	16 January 2027	100%	100%
Mick Well	E09/2320	Kingfisher Mining Ltd	Granted	12	20 March 2029	100%	100%
	E09/2495	Kingfisher Mining Ltd	Granted	50	10 April 2027	100%	100%
	E09/2653	Kingfisher Mining Ltd	Granted	14	20 July 2027	100%	100%
Arthur River	E09/2494	Kingfisher Mining Ltd	Granted	26	11 April 2027	100%	100%
	E09/2523	Kingfisher Mining Ltd	Granted	10	4 April 2027	100%	100%
Chalba	E09/2654	Kingfisher Mining Ltd	Granted	35	28 August 2027	100%	100%
	E09/2655	Kingfisher Mining Ltd	Granted	14	20 July 2027	100%	100%
Mooloo	E09/2660	Kingfisher Mining Ltd	Granted	10	31 October 2027	100%	100%
	E09/2661	Kingfisher Mining Ltd	Granted	18	1 November 2027	100%	100%

### Tenements acquired or disposed during the quarter

Project	Tenement	Nature of Interest	Interest Held @ 31-Mar-25	Interest Held @ 30-Jun-25
Mick Well	E09/2320	Partial Surrender Voluntary	12BL	12BL

## Appendix 5B

### Mining exploration entity or oil and gas exploration entity quarterly cash flow report

Name of entity

Kingfisher Mining Limited

ABN

96 629 675 216

Quarter ended ("current quarter")

30 June 2025

<b>Consolidated statement of cash flows</b>	<b>Current quarter \$A'000</b>	<b>Year to date (12 months) \$A'000</b>
<b>1. Cash flows from operating activities</b>		
1.1 Receipts from customers	-	-
1.2 Payments for		
(a) exploration & evaluation	-	-
(b) development	-	-
(c) production	-	-
(d) staff costs	(43)	(190)
(e) administration and corporate costs	(77)	(390)
1.3 Dividends received (see note 3)	-	-
1.4 Interest received	11	37
1.5 Interest and other costs of finance paid	(1)	(4)
1.6 Income taxes paid	-	-
1.7 Government grants and tax incentives	-	-
1.8 Other (provide details if material)	-	-
<b>1.9 Net cash from / (used in) operating activities</b>	<b>(110)</b>	<b>(547)</b>
<b>2. Cash flows from investing activities</b>		
2.1 Payments to acquire or for:		
(a) entities	-	-
(b) tenements	-	-
(c) property, plant and equipment	-	-
(d) exploration & evaluation	(42)	(820)
(e) investments	-	-
(f) other non-current assets	-	-

## Mining exploration entity or oil and gas exploration entity quarterly cash flow report

Consolidated statement of cash flows		Current quarter \$A'000	Year to date (12 months) \$A'000
2.2	Proceeds from the disposal of:		
	(a) entities	-	-
	(b) tenements	-	-
	(c) property, plant and equipment	-	-
	(d) investments	-	1,333
	(e) other non-current assets	-	-
2.3	Cash flows from loans to other entities	-	-
2.4	Dividends received (see note 3)	-	-
2.5	Other (Government Exploration Incentive Scheme – Co-funded Drilling)	-	181
<b>2.6</b>	<b>Net cash from / (used in) investing activities</b>	<b>(42)</b>	<b>694</b>

<b>3.</b>	<b>Cash flows from financing activities</b>		
3.1	Proceeds from issues of equity securities (excluding convertible debt securities)	-	-
3.2	Proceeds from issue of convertible debt securities	-	-
3.3	Proceeds from exercise of options	-	-
3.4	Transaction costs related to issues of equity securities or convertible debt securities	-	-
3.5	Proceeds from borrowings	-	-
3.6	Repayment of borrowings	(5)	(20)
3.7	Transaction costs related to loans and borrowings	-	-
3.8	Dividends paid	-	-
3.9	Other (provide details if material)	-	-
<b>3.10</b>	<b>Net cash from / (used in) financing activities</b>	<b>(5)</b>	<b>(20)</b>

<b>4.</b>	<b>Net increase / (decrease) in cash and cash equivalents for the period</b>		
4.1	Cash and cash equivalents at beginning of period	1,629	1,345
4.2	Net cash from / (used in) operating activities (item 1.9 above)	(110)	(547)
4.3	Net cash from / (used in) investing activities (item 2.6 above)	(42)	694
4.4	Net cash from / (used in) financing activities (item 3.10 above)	(5)	(20)

## Mining exploration entity or oil and gas exploration entity quarterly cash flow report

<b>Consolidated statement of cash flows</b>		<b>Current quarter \$A'000</b>	<b>Year to date (12 months) \$A'000</b>
4.5	Effect of movement in exchange rates on cash held	-	-
<b>4.6</b>	<b>Cash and cash equivalents at end of period</b>	<b>1,472</b>	<b>1,472</b>

<b>5.</b>	<b>Reconciliation of cash and cash equivalents</b> at the end of the quarter (as shown in the consolidated statement of cash flows) to the related items in the accounts	<b>Current quarter \$A'000</b>	<b>Previous quarter \$A'000</b>
5.1	Bank balances	152	734
5.2	Call deposits	1,320	895
5.3	Bank overdrafts	-	-
5.4	Other (provide details)	-	-
<b>5.5</b>	<b>Cash and cash equivalents at end of quarter (should equal item 4.6 above)</b>	<b>1,472</b>	<b>1,629</b>

<b>6.</b>	<b>Payments to related parties of the entity and their associates</b>	<b>Current quarter \$A'000</b>
6.1	Aggregate amount of payments to related parties and their associates included in item 1	43
6.2	Aggregate amount of payments to related parties and their associates included in item 2	-

*Note: if any amounts are shown in items 6.1 or 6.2, your quarterly activity report must include a description of, and an explanation for, such payments.*

Includes Directors' salaries, fees and superannuation.

For personal use only

## Mining exploration entity or oil and gas exploration entity quarterly cash flow report

7. <b>Financing facilities</b> <i>Note: the term "facility" includes all forms of financing arrangements available to the entity. Add notes as necessary for an understanding of the sources of finance available to the entity.</i>	<b>Total facility amount at quarter end \$A'000</b>	<b>Amount drawn at quarter end \$A'000</b>
7.1 Loan facilities	-	-
7.2 Credit standby arrangements	-	-
7.3 Other (please specify)	-	-
7.4 <b>Total financing facilities</b>	-	-
7.5 <b>Unused financing facilities available at quarter end</b>		-
7.6 Include in the box below a description of each facility above, including the lender, interest rate, maturity date and whether it is secured or unsecured. If any additional financing facilities have been entered into or are proposed to be entered into after quarter end, include a note providing details of those facilities as well.	N/A	

8. <b>Estimated cash available for future operating activities</b>	<b>\$A'000</b>
8.1 Net cash from / (used in) operating activities (item 1.9)	(110)
8.2 (Payments for exploration & evaluation classified as investing activities) (item 2.1(d))	(42)
8.3 Total relevant outgoings (item 8.1 + item 8.2)	(152)
8.4 Cash and cash equivalents at quarter end (item 4.6)	1,472
8.5 Unused finance facilities available at quarter end (item 7.5)	-
8.6 Total available funding (item 8.4 + item 8.5)	1,472
8.7 <b>Estimated quarters of funding available (item 8.6 divided by item 8.3)</b>	9.7
<i>Note: if the entity has reported positive relevant outgoings (ie a net cash inflow) in item 8.3, answer item 8.7 as "N/A". Otherwise, a figure for the estimated quarters of funding available must be included in item 8.7.</i>	
8.8 If item 8.7 is less than 2 quarters, please provide answers to the following questions:	
8.8.1 Does the entity expect that it will continue to have the current level of net operating cash flows for the time being and, if not, why not?	
Answer: N/A	
8.8.2 Has the entity taken any steps, or does it propose to take any steps, to raise further cash to fund its operations and, if so, what are those steps and how likely does it believe that they will be successful?	
Answer: N/A	

## Mining exploration entity or oil and gas exploration entity quarterly cash flow report

8.8.3 Does the entity expect to be able to continue its operations and to meet its business objectives and, if so, on what basis?

Answer: N/A

Note: where item 8.7 is less than 2 quarters, all of questions 8.8.1, 8.8.2 and 8.8.3 above must be answered.

### Compliance statement

- 1 This statement has been prepared in accordance with accounting standards and policies which comply with Listing Rule 19.11A.
- 2 This statement gives a true and fair view of the matters disclosed.

Date: 31 July 2025

Authorised by: By the Board of Kingfisher Mining Limited  
(Name of body or officer authorising release – see note 4)

### Notes

1. This quarterly cash flow report and the accompanying activity report provide a basis for informing the market about the entity's activities for the past quarter, how they have been financed and the effect this has had on its cash position. An entity that wishes to disclose additional information over and above the minimum required under the Listing Rules is encouraged to do so.
2. If this quarterly cash flow report has been prepared in accordance with Australian Accounting Standards, the definitions in, and provisions of, *AASB 6: Exploration for and Evaluation of Mineral Resources* and *AASB 107: Statement of Cash Flows* apply to this report. If this quarterly cash flow report has been prepared in accordance with other accounting standards agreed by ASX pursuant to Listing Rule 19.11A, the corresponding equivalent standards apply to this report.
3. Dividends received may be classified either as cash flows from operating activities or cash flows from investing activities, depending on the accounting policy of the entity.
4. If this report has been authorised for release to the market by your board of directors, you can insert here: "By the board". If it has been authorised for release to the market by a committee of your board of directors, you can insert here: "By the [name of board committee – eg Audit and Risk Committee]". If it has been authorised for release to the market by a disclosure committee, you can insert here: "By the Disclosure Committee".
5. If this report has been authorised for release to the market by your board of directors and you wish to hold yourself out as complying with recommendation 4.2 of the ASX Corporate Governance Council's *Corporate Governance Principles and Recommendations*, the board should have received a declaration from its CEO and CFO that, in their opinion, the financial records of the entity have been properly maintained, that this report complies with the appropriate accounting standards and gives a true and fair view of the cash flows of the entity, and that their opinion has been formed on the basis of a sound system of risk management and internal control which is operating effectively.

For personal use only